

TG9 Series

T5709 .02

Electronic Bell - 2 module Quartz Gray

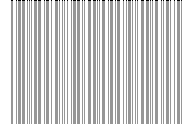
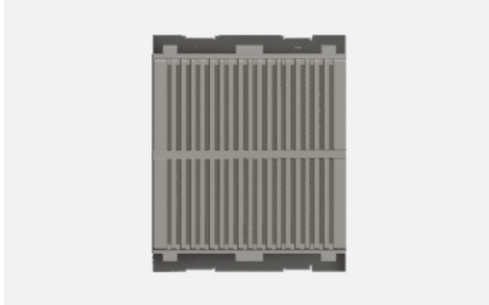

5267.51.8



Code:	T5709 .02
Series:	TG9 Series
Family:	Acoustic and Optical Signaling
Module Size:	Two Module
Colour:	Quartz Gray
Mark:	Norisys
Rated supply voltage:	240V A.C - 50Hz
Maximum resistive load:	----
Dimensions:	55.6mm x 44.9mm x 50.0mm
Weight:	59.80g

Wiring Diagram:

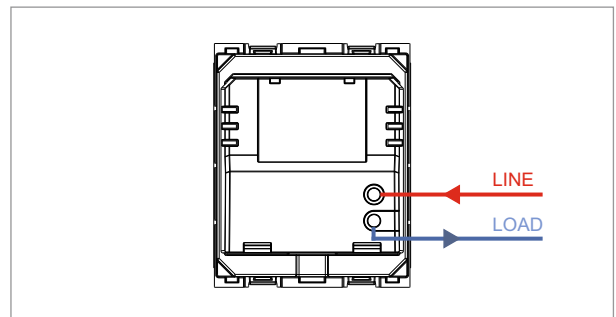

Drawings:

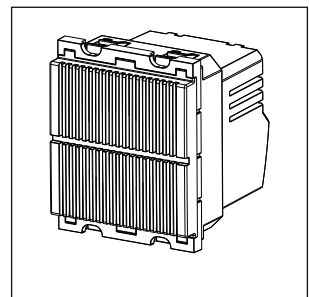
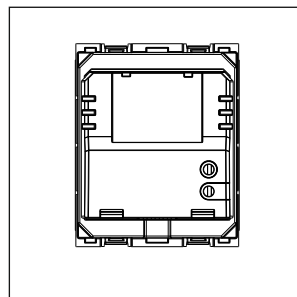
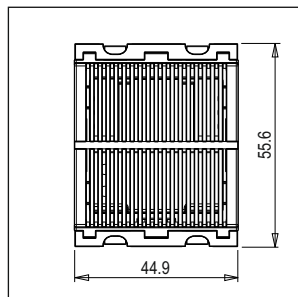
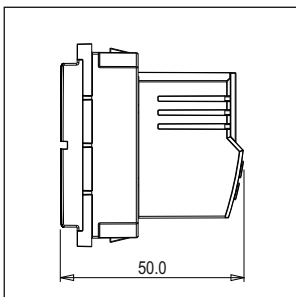

Installation:

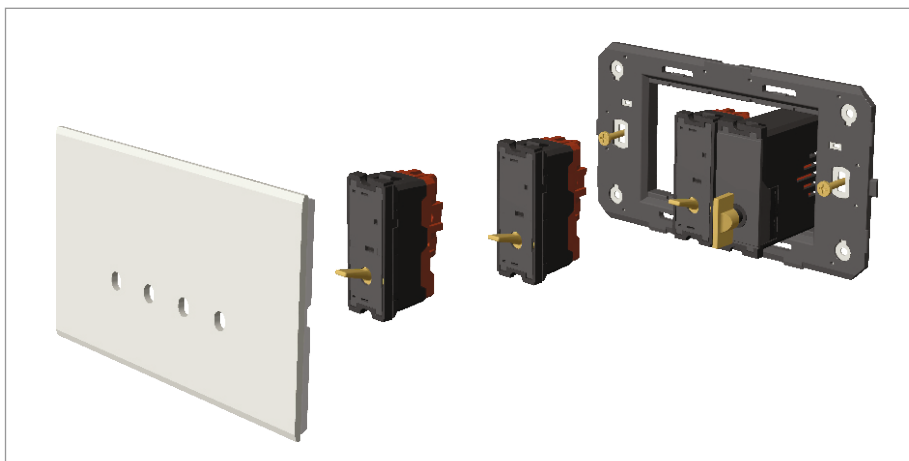

Installation of the product should be carried out in compliance with the current regulations regarding the installation of electrical systems in the country where the product is installed.

The product should be installed by a trained professional following all safety norms.

Keep away from water and wet surfaces. While mounting the product, hands should not be wet.