

SQUARE Series

S7602 .01

2M Plate Frost White

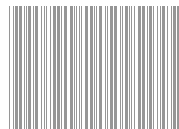
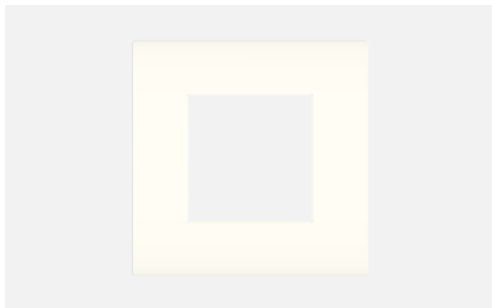

5267.51.8



Code:	S7602 .01
Series:	SQUARE Series
Family:	Smart Plate with frames
Module Size:	Two Module
Colour:	Frost White
Mark:	Norisys
Rated supply voltage:	--
Maximum resistive load:	--
Dimensions:	92mm x 90.5mm x 16.7mm
Weight:	53.7g

Wiring Diagram:

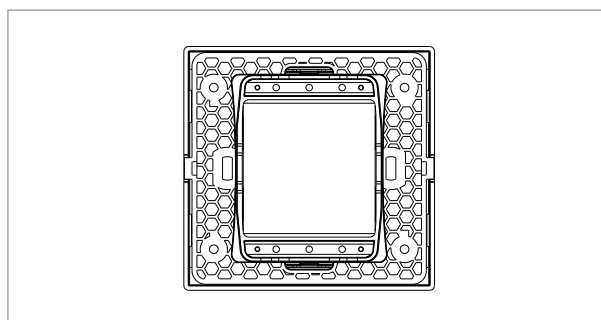

Drawings:

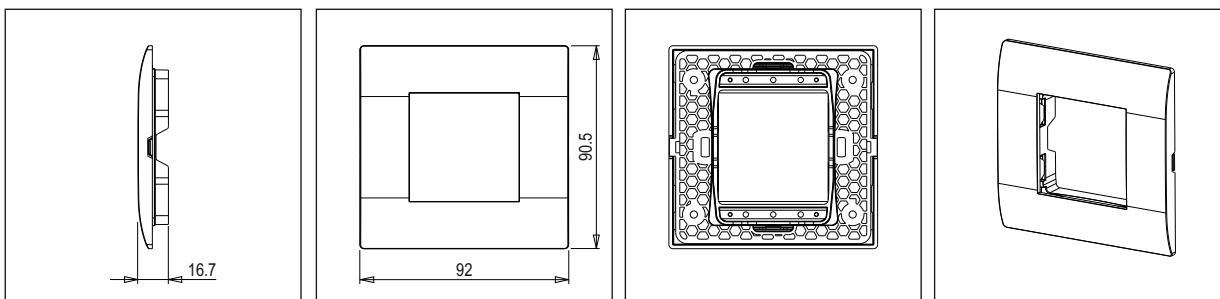

Installation:

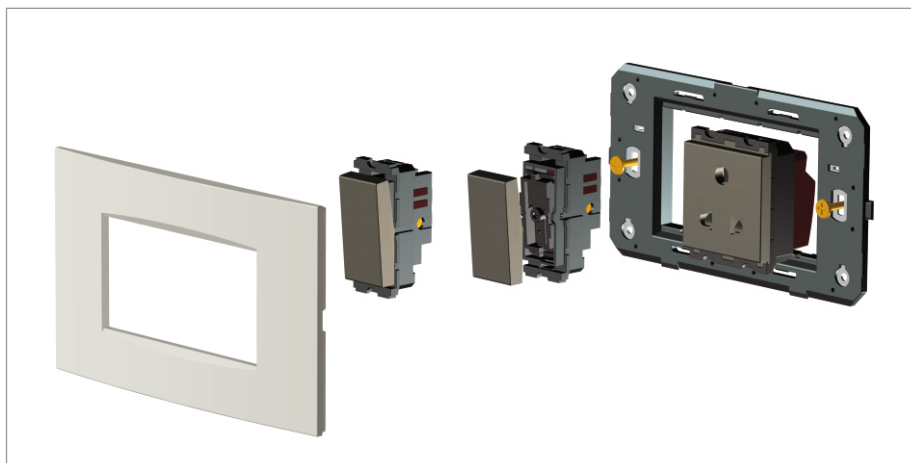

Installation of the product should be carried out in compliance with the current regulations regarding the installation of electrical systems in the country where the product is installed.

The product should be installed by a trained professional following all safety norms.

Keep away from water and wet surfaces. While mounting the product, hands should not be wet.