

Switches Sockets and Accessories
Product Information and Catalogue



Company Overview

A Professional of electrical switchgear, Norisys constructs innovative switchgear systems and has established itself by many years of experience and high quality workmanship. Norisys is committed to being recognised as a premier destination for electrical products.

Each day Norisys engineers work to bring about a combination of innovative designs and materials using advanced manufacturing technology in order to create products that are best suited to meet user requirements.

We continuously strive to upgrade processes and materials. CUBE Series and SQUARE Series products thus ensure sound electrical performance.

Products such as Modular MCBs, Single Phase Motor Starters, Power Units for airconditioners are all products made by Norisys, and have today become common household products. Quality is ensured at every stage.



The manufacturing plant is equipped with modern state-of-the-art machinery and equipment. In-house facilities for testing and quality assurance of all components ensure guaranteed quality. Extensive material selection process and rigorous quality monitoring process is followed for conformity to highest standards.

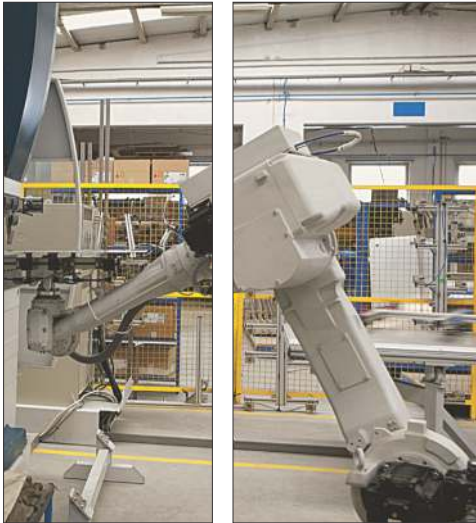

All products from Norisys have been developed to establish new standards in electrical accessories. Commitment to superior designs, elaborate attention to engineering details, modern manufacturing facilities and stringent quality measures have combined together to create a new concept in safety, reliability, flexibility and modernity.

Norisys has a full fledged, well equipped research and development division which works constantly to improve, innovate and engineer new products. This research and development division has a fully integrated product development environment that directs the development process throughout - right from conceptual design to manufacturing.

All Norisys products are designed for extreme endurance. Materials are chosen to withstand arduous conditions. Local wiring practices are carefully studied before designing any new product at Norisys. This ensures ease of installation and durability of the products.

Bi-material Frames engineered for toughness

CUBE Series products are designed for tough performance. The products are mounted in a way that the entire pressure of wires in the junction box is borne entirely by a sturdy bi-material frame.

by this mechanism and it maintains uniform gaps between the modules. This mechanism uses locks which remain free from any stress after mounting, thus making the system extremely durable with long life.

4

The bi-material support frames in CUBE Series is the result of several man-hours of research and development. The bi-material frames are made of a combination of steel and engineering grade plastic. In this design, the steel structure is embedded into plastic. The steel inside gives the bi-material frame a rigid structure while the plastic provides the anti-rust and insulation properties.

Wiring connections can be made upon fixing the modules on the bi-material frames. Cover plates can be mounted after final painting of walls, thus preventing the plates from getting soiled during construction and painting work.

Modules are mounted on the bi-material frames using a unique snap-fit mechanism. This snap-fit mechanism is highly accurate thereby ensuring that all modules fit comfortably without the need of force. Location of the modules on the bi--material frames is controlled

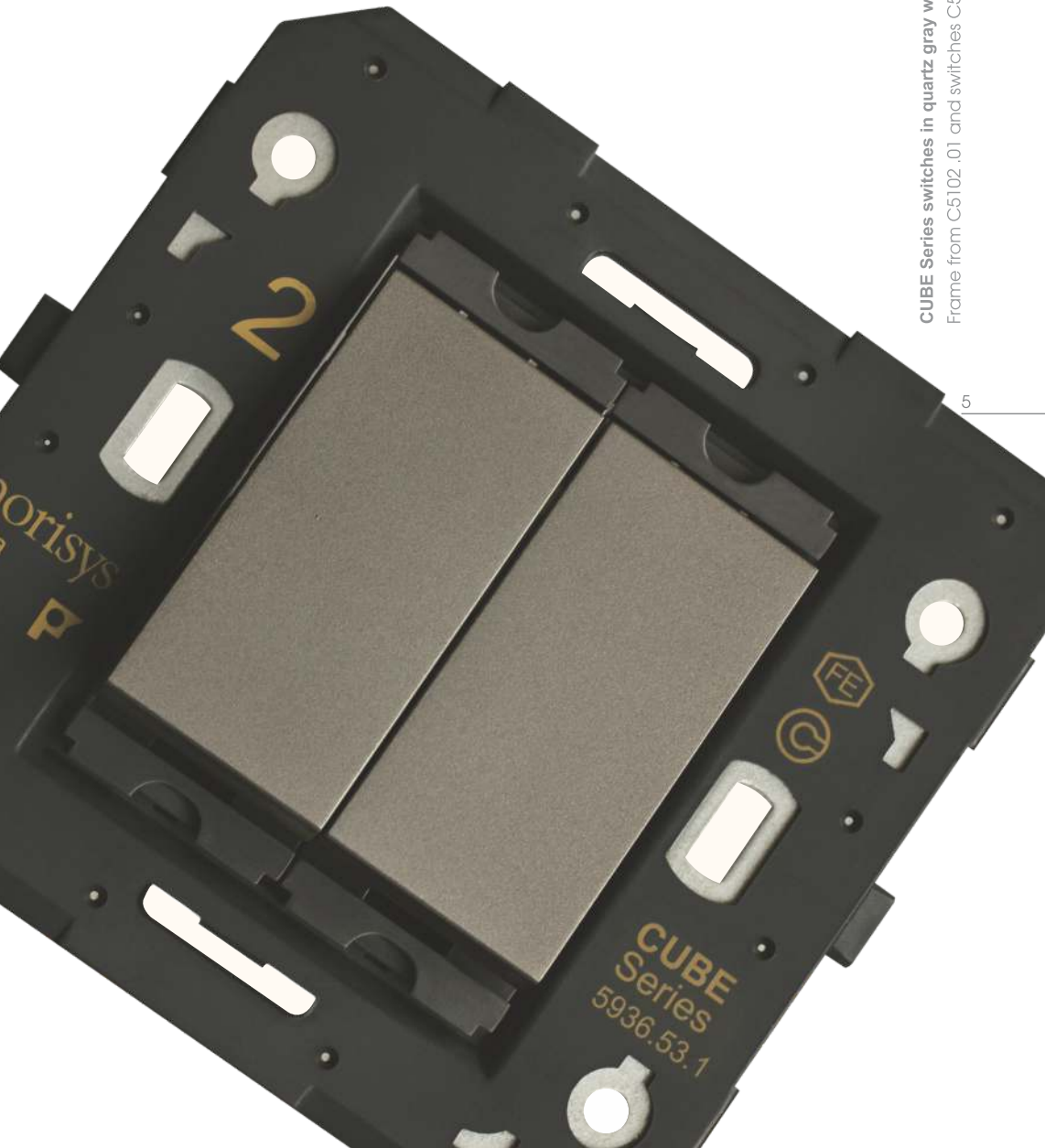

CUBE Series switches in quartz gray with a two module frame
Frame from C5102.01 and switches C5110.02

CUBE Series

CUBE Series is a modular product range which is designed to satisfy the requirements of electrical installations in modern buildings.

The range includes switches, sockets, fan regulators & dimmers, hospitality products, communication sockets, acoustic and optical signaling products, cover plates etc.

Modules such as switches, sockets etc. are made to a standard size (module) which are mounted on frames. Front plates are available in a variety of colours, materials and finish. The front plates can be changed at any time without disturbing the wiring to adapt to changes in building interiors.

Use of engineering grade thermoset materials in CUBE Series products makes the range extremely strong and sturdy with flame proof qualities. The engineering grade thermoset material used in the products has

excellent electrical insulation properties and does not catch fire. This ensures that the products are capable of handling higher operating temperatures. This engineering grade thermoset material is conventionally used in industrial applications where high degree of electrical insulation is required.

CUBE Series quartz gray switches & sockets with solid wood plate
Switches C5110 .02 Socket C5212 .02 and Plate CW304 .06

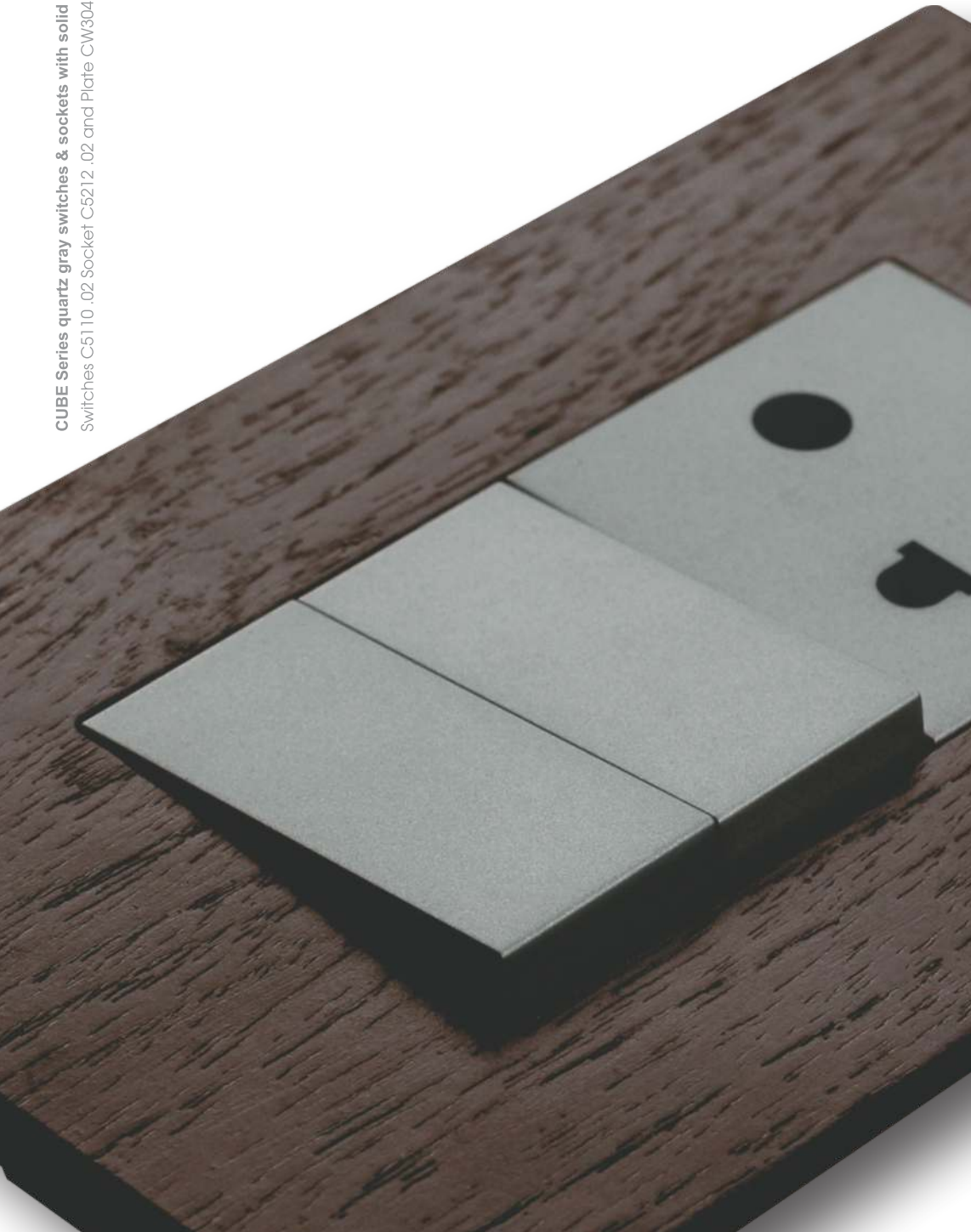

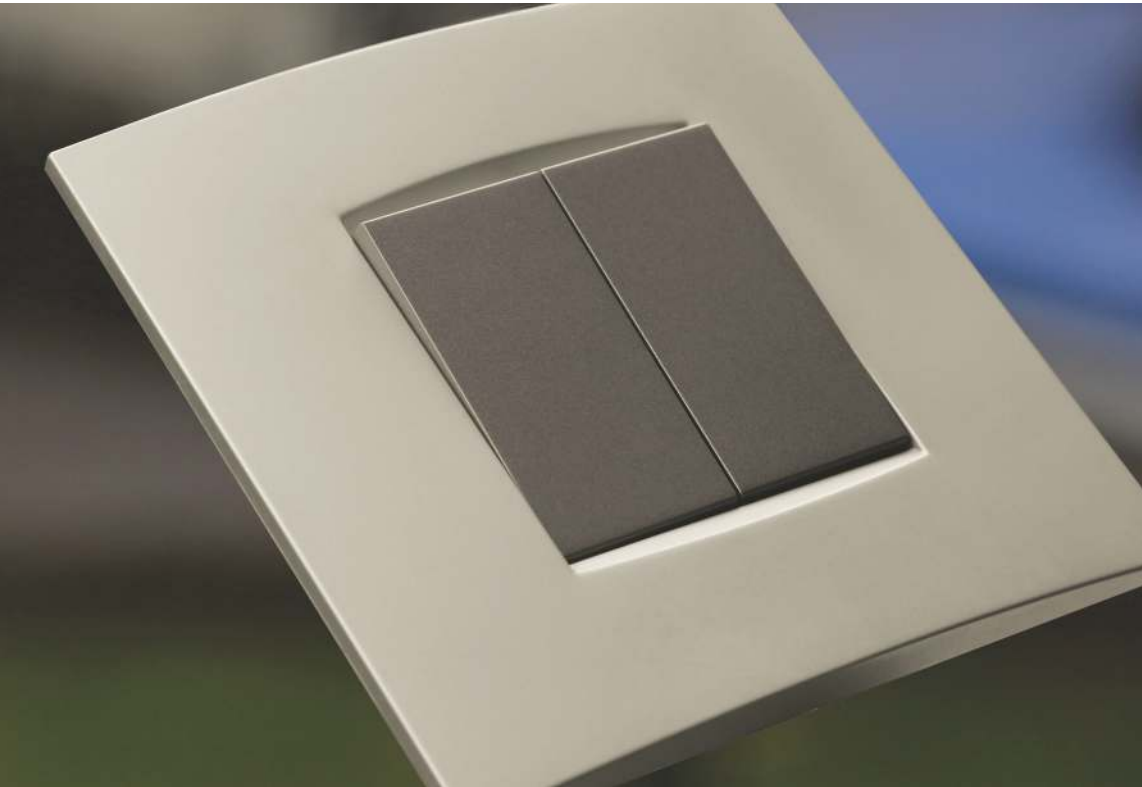

Norisy engineers have been working day after day with diligence in order to ensure consistent electrical, mechanical and thermal qualities.

CUBE Series

the technology inside

CUBE Series switches have contacts which provide very high current carrying capacity. The contact design, snap action mechanism, appropriate contact pressure, wiping action between the contacts and use of high engineering grade materials result in minimum arcing. Reduction in arcing ensures a very long operating life for the switches.

Proper shrouding of terminals and current carrying parts is provided in all switches and sockets. Since the live parts are separated by thermoset material, they are prevented from fusing together in case of any over-heating.

LED indicators used in the CUBE Series switches emit a soft, reassuring glow which is mild and soothing to the eyes. Use of high quality LEDs ensures a long indicator life without flicker.

Norisys engineers developed a unique ring-shaped spring which solves the frequently occurring problem of burnouts in power sockets. Norisys sockets feature this ring-shaped spring which maintains a uniform pressure on the brass contact tubes. This pressure clamps the plug pins tightly leading to a firm spark-free contact, thus eliminating overheating and consequential burnouts.

CUBE Series sockets are child protected. Safety shutters have been put in place to prevent any accidental contact with live parts thereby reducing risk of electric shocks.

CUBE Series

tiny mcb - modular mcb system

Tiny MCB is a high performance and a reliable safety device, which has now become a common household product. It is a modular MCB that can be mounted simply like a switch. These MCBs are front mounted along with switches, sockets etc. of CUBE Series or SQUARE Series products. Tiny MCB can also be mounted on sunmica sheets of any existing or new receptacle commonly used in household wiring.

Single Pole and Double Pole versions are available in Tiny MCB in various ratings. Distribution Boards for single phase are made using Tiny MCBs on CUBE Series or SQUARE Series plates or even on sunmica sheets. These distribution boards are compact and smart. When mounted with a 25Ampere socket, it offers the perfect solution for switching airconditioners and geysers.

Tiny MCBs are high performance devices that incorporate advanced developments in electrical engineering technology for protection of circuits and individual appliances. They are typically used for switching and protection of air-conditioners, geysers, pumps, heaters and other appliances that draw high current in domestic applications. These MCBs are also used as a master switch in rooms to switch off the entire circuit in a room for energy saving.



Solid Aluminum Black Finish Plate with quartz gray switches
Plate CA304 .05 Switches C5110 .02 Bell C5310 .02

CUBE Series

fan regulators & vector plates

Fan regulator in CUBE Series demonstrates the way engineers at Norisys pay attention to product details. The knob featured in this device solves the common problem of knobs coming off or falling. The dual knob design ensures that the knob cannot be pulled out, thus ensuring that the knobs remain intact even after years of usage.

The unique bar shaped knob is a visual treat and blends with modern interiors, besides being ergonomic. The bar shaped knob is easy to grip and is much more comfortable to operate than regular circular ones.

This fan regulator is a totally dependable device that eliminates failures normally experienced with electronic regulators. It has full rotation operation with no end point, thereby preventing any undue pressure from damaging the regulator. Total hum-free operation, six speeds of operation,

no radio interference and negligible power loss are other benefits of this regulator.

CUBE Series Vector Plates incorporate a redefined design capable of harmoniously blending into different living styles. These plates are available in Frost White, Quartz Grey and Ice Silver colour options. The shape of these plates is urbane and exudes aesthetic elegance. These plates are made from high gloss virgin grade UV stabilized engineering plastics.



Vector Plate in Ice Silver colour with two switches & fan regulator

Plate C5404 .03 Switches C5110 .01 Fan Regulator C5900 .01

Each piece of Solid Aluminum plate is machined out of a solid block of aluminum to give it the sharp and clean look. These plates are available in natural finish and black finish and match very well with Frost White modules and Quartz Gray modules. The complete look is a solid, well engineered smart composition.



Solid Aluminum Plate with emergency light & step marker
Plate CA304 .04 Emer Light C5715 .01 Step Marker C5721 .01

CUBE Series

special material machined plates

Norisys special material plates set the standards for stylish design combined with top quality materials: Solid Aluminum, Solid Glass, Solid Wood, Solid Marble finish. The classy design creates an exclusive flair owing to the interaction of contrasts between the severity of optical forms and surface finish.

Solid glass plates are made of engineered glass which is tempered and toughened to make it rugged and to impart a nice uniform lustre. Solid glass plates are available in Ice White and Metal Gray colours. Both the options provide a radiance to the interiors.

Solid Wood plates are crafted out of best quality natural wood, which is treated and seasoned to ensure a long life. These plates are offered in Natural Pinewood Polish and Dark Mahogany Polish. Special Protective coatings and surface hardeners make the surface wear

resistant. Wood lends a natural feel to the clean edges of engineering plastics and metals. This natural feel can be an asset for interior designers for making the electrical outlets blend with the furniture.

Solid Marble finish plates are individually machined from solid blocks so that the end product is a crisp clean cut flat plate which looks modern in aesthetics. The Sparkle White option matches very well with white marble whereas the Terra Beige option matches very well with marbles from the Beige and Brown family. Once mounted alongwith the CUBE Series modules, it merges the looks of technical accuracy with natural marble feel.

CUBE Series

CUBE Series marks the evolution of Norisys' research as it once again focuses on engineering design, especially its environmental qualities, and pivots on the concepts of variability and sustainability, performance and simplicity of use.

16

It is a new way of creating environments, made possible by the types of products that have been developed, namely by using advanced materials and engineering. The result is an installation system that seamlessly blends with the building.

As a professional of electrical switchgear, today Norisys constructs innovative switchgear systems at the highest level and has established itself by sheer experience and high quality workmanship. The two product ranges namely CUBE Series and SQUARE Series, make sure that products are available for highly specific requirements as well.

In CUBE Series switches, the spring geometry of the moving contact of the mechanism has a natural cushioning function, which significantly reduces its electrical recoil as well as wear. An increase in the quantum of silver in the contacts, helps to reconcile the safety of electric switching with smoothness of operation.



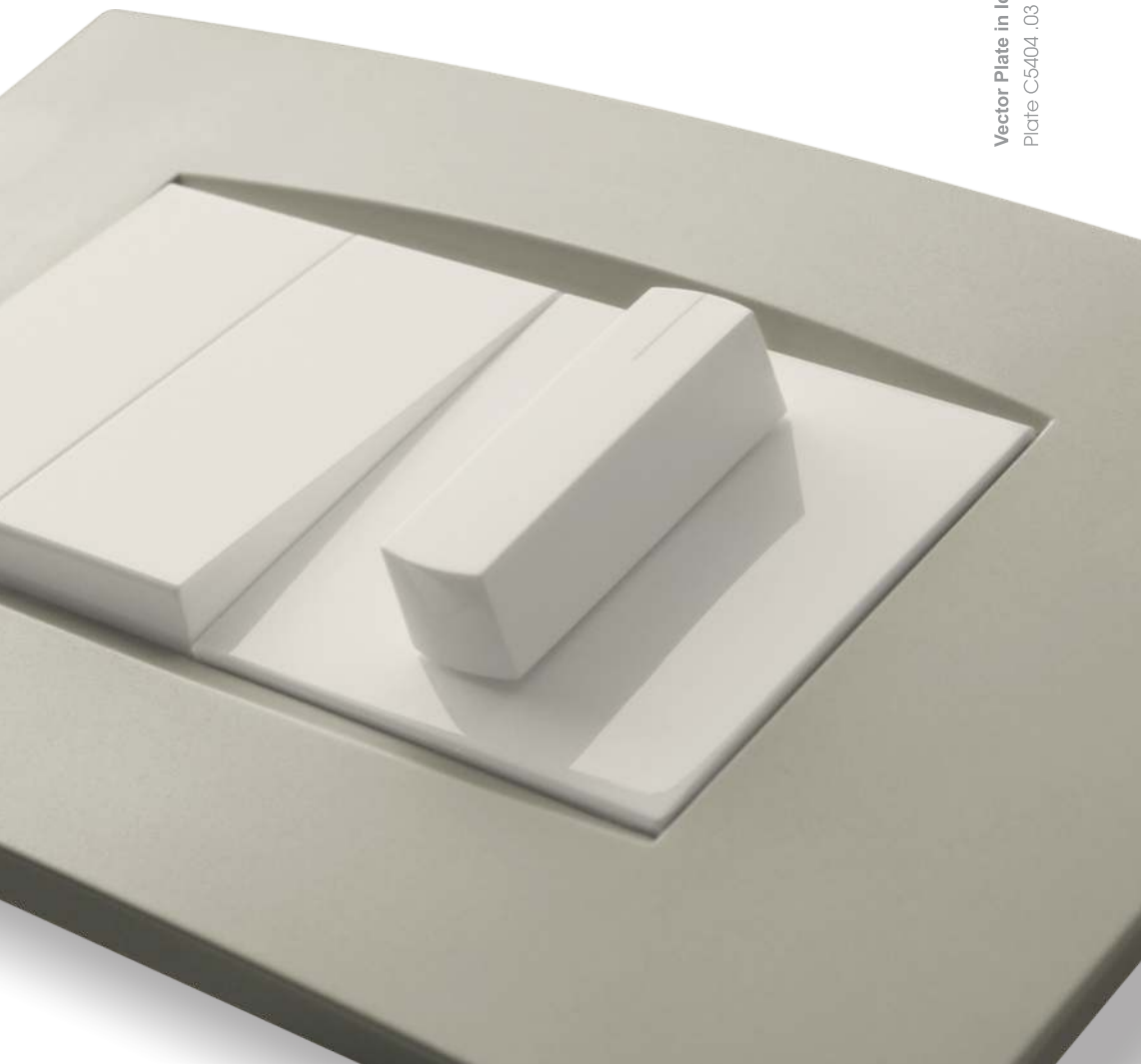

Vector Plate in Ice Silver colour with two switches & fan regulator
Plate C5404 .03 Switches C5110 .01 Fan Regulator C5900 .01

Architecture of modern hotels and hospitals makes the highest demand for design and function of electrical installations. NorisyS offers high-end products suited for the hospitality industry.



CUBE Series

hotel installation systems

CUBE Series installations do not only look good, they are also ideally convenient to operate. Especially for use in hotels and hospitals where one seeks quiet and wellbeing. It is important to have fittings that stand for good feeling.

Products like Shaver Sockets, Key Card Switches, Call bell system with register, Buzzers, Speakers for Music circuits, Step Marker Night Light, Do Not Disturb and Clean My Room dedicated switches, Bell Switch with DND & Clean My Room connections provide the necessary convenience for guests in hotels.

Smart Plates in CUBE Series have a distinct classic design offering comfort to the eye. The plates merge with the interiors very well creating a homogeneous look. Inner bi-material frames give adequate support to the plates keeping all the modules securely in place without yielding to pressure from the wires inside or during insertion / removal of plug tops.

Good quality data sockets are a prerequisite at all workplaces because of increasing speeds in data transmission. Norisys communication sockets are available for all types of telephone and data connections. Shutters for dust protection is provided in all data sockets along with a circuit marking label with a clear cover. The marking can give clear indication on the data line connected to the socket. Communication sockets are available for Cat 5, Cat 6, RJ-11 lines.

CUBE Series

single phase motor starters

Single Phase Motor Starters - a safety device designed by Norisys engineers with advanced current handling. It is a device for switching and protection of appliances such as room air-conditioners, refrigerators, washing machines, computers, water coolers, pumps etc. up to 25Amperes. In case of overload, the Single Phase Motor Starter trips, thereby protecting the appliance from burn-out.

These starters are normally mounted with sockets from CUBE Series or SQUARE Series. This combination forms an efficient module for single phase applications. The unit is compact and economical and is operated by the push of buttons located in the front of the Starter.

Installation of Single Phase Motor Starters is very simple as they can be installed simply like a switch. They can also be mounted on Surface Mount Boxes from Norisys for an elegant stylized look.

The unique feature of Single Phase Motor Starters is the facility of current setting. The starter tripping can be precisely set as per the requirement of the individual appliance. This setting can be done simply by the turn of a screw provided on the front panel of the starter. After setting the starter tripping current, the device protects the appliance from overloads with desired precision.

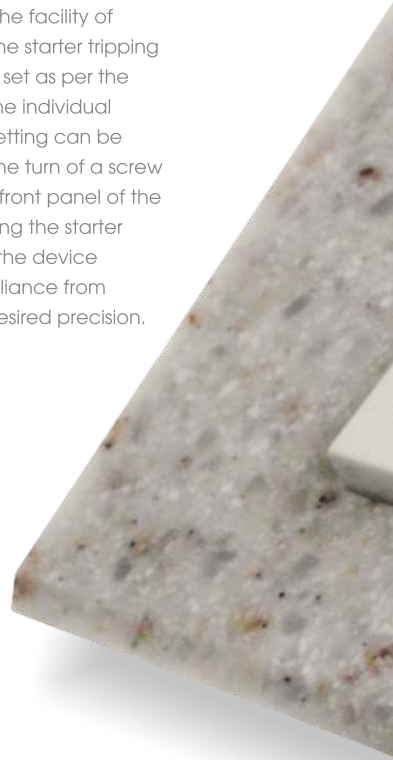



Solid Marble Finish Plate Terra Beige with switches in Frost White
Plate CM304.11 Switches C5110.01 & Fan Regulator C5900.01

SQUARE Series

SQUARE Series products is a design which has evolved over a period of time. Functional qualities and the mounting system is proven and the technology tested. Classic looks of this range makes it a timeless design.

UV stabilized virgin grade poly-carbonate material is used in SQUARE Series to impart a highly polished glossy surface. Locators in the modules and frames facilitate accuracy in mounting ensuring uniform gaps between the modules. Spring loaded tubes in sockets ensure a firm contact with plug pins for smooth operation.

22

Unique feature of this Series is the mounting system. All modules are mounted on frames using screws. This makes the assembly very sturdy. The modules which are mounted by screws can withstand tremendous amount of pressure. Back housing of sockets rest on the frame and provides a firm support - required in case of excessive push pressure while inserting plugs.

SQUARE Series products retain the special features offered by the company in the past, yet have been redesigned for modernity. Use of thermoset material for the core areas makes the switches and sockets highly durable and capable of handling higher currents.





SQUARE Series switches in frost white with a two module frame
Frame from S7602 .01 and switches S7110 .01



C5110 .01
C5130 .01
C5730 .01



C5210 .01
C5230 .01



C5310 .01



C5441 .01

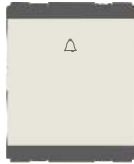

C5340 .01

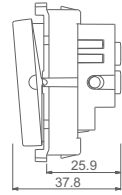

C5111 .01
C5131 .01
C5731 .01



C5211 .01
C5231 .01



C5311 .01



C5431 .01

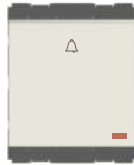

C5341 .01

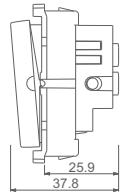

C5140 .01
C5160 .01



C5180 .01



C5240 .01
C5260 .01

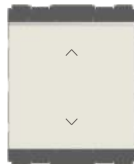

C5280 .01

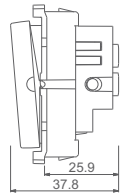

C5141 .01
C5161 .01



C5191 .01
C5171 .01



C5241 .01
C5261 .01

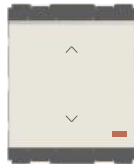

C5281 .01
C5291 .01

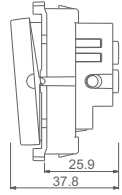

CUBE Series

Switches Frost White

Cat no.	Description
C5110 .01	Switch 6A One-way - 1 Module
C5111 .01	Switch 6A One-way with indicator - 1 Module
C5210 .01	Switch 6A Two-way - 1 Module
C5211 .01	Switch 6A Two-way with indicator - 1 Module
C5130 .01	Switch 16A One-way - 1 Module
C5131 .01	Switch 16A One-way with indicator - 1 Module
C5230 .01	Switch 16A Two-way - 1 Module
C5231 .01	Switch 16A Two-way with indicator - 1 Module
C5730 .01	Switch 25A One-way - 1 Module
C5731 .01	Switch 25A One-way with indicator - 1 Module
C5310 .01	Switch 6A - Bell - 1 Module
C5311 .01	Switch 6A - Bell with indicator - 1 Module
C5140 .01	Palm Switch 6A One-way Single Pole - 2 Module
C5141 .01	Palm Switch 6A One-way Single Pole with indicator - 2 Module
C5240 .01	Palm Switch 6A Two-way Single Pole - 2 Module
C5241 .01	Palm Switch 6A Two-way Single Pole with indicator - 2 Module
C5160 .01	Palm Switch 16A One-way Single Pole - 2 Module
C5161 .01	Palm Switch 16A One-way Single Pole with indicator - 2 Module
C5260 .01	Palm Switch 16A Two-way Single Pole - 2 Module
C5261 .01	Palm Switch 16A Two-way Single Pole with indicator - 2 Module
C5180 .01	Palm Switch 6A One-way Double Pole - 2 Module
C5280 .01	Palm Switch 6A Two-way Double Pole - 2 Module
C5281 .01	Palm Switch 6A Two-way Double Pole with indicator - 2 Module
C5191 .01	Palm Switch 16A One-way Double Pole with indicator - 2 Module
C5291 .01	Palm Switch 16A Two-way Double Pole with indicator - 2 Module
C5171 .01	Palm Switch 25A One-way Double Pole with indicator - 2 Module
C5340 .01	Palm Bell Switch Single Pole - 2 Module
C5341 .01	Palm Bell Switch Single Pole with indicator - 2 Module
C5441 .01	Switch 16A One-way with 'Geyser' Symbol with indicator - 1 Module
C5431 .01	Switch 6A One-way with 'Fan' or 'Light' or 'Exhaust' symbol - 1 Module



C2110.01



C2111.01



C2010.01



C2011.01



C2130.01

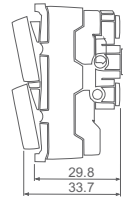

C2131.01



C2030.01



C2031.01



C2140.01



C2141.01

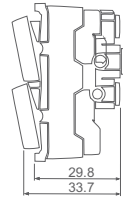

C2040.01



C2041.01

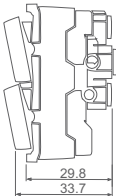

CUBE Series

Twin Switches Frost White

Cat no.	Description
C2110 .01	Twin Switch 6A - 2 Gang - Both switches 1 way - 1 Module
C2111 .01	Twin Switch 6A - 2 Gang - 1 way + 1 way with indicator - 1 Module
C2010 .01	Twin Switch 6A - 1 Gang - 2 way + Dummy - 1 Module
C2011 .01	Twin Switch 6A - 1 Gang - 2 way with indicator + Dummy - 1 Module
C2130 .01	Twin Switch 16A - 2 Gang - Both switches 1 way - 1 Module
C2131 .01	Twin Switch 16A - 2 Gang - 1 way + 1 way with indicator - 1 Module
C2030 .01	Twin Switch 16A - 1 Gang - 2 way + Dummy - 1 Module
C2031 .01	Twin Switch 16A - 1 Gang - 2 way with indicator + Dummy - 1 Module
C2140 .01	Twin Switch 6A - 2 Gang - Both Switches Bell - 1 Module
C2141 .01	Twin Switch 6A - 2 Gang - 1 Bell + 1 Bell with Indicator - 1 Module
C2040 .01	Twin Switch 6A - 1 Gang - 1 Bell + 1 Dummy - 1 Module
C2041 .01	Twin Switch 6A - 1 Gang - 1 Bell with Indicator + 1 Dummy - 1 Module

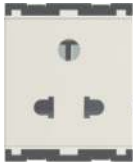

C5212 .01



C5332 .01



C5732 .01

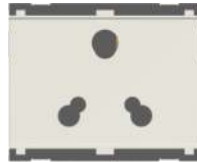

C5552 .01

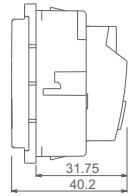

C5532 .01



C5900 .01



C5901 .01

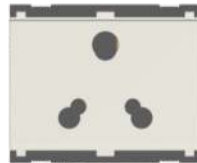

C5752 .01

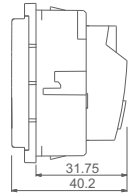

C5902 .01
C5903 .01
C5909 .01



C5910 .01



C5911 .01



C5331 .01
C5733 .01

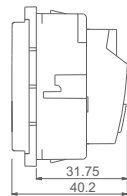

C5010 .01



C5904 .01



C5905 .01
C5908 .01



C5531 .01



C5213 .01



CUBE Series

Sockets Frost White

Cat no.	Description
C5212 .01	Socket 6A 3+2 Pin [Round & Flat] Shuttered - 2 Module
C5213 .01	Socket 6A 3-Pin-only Shuttered - 2 Module
C5010 .01	Socket 6A 2 Pin [Round & Flat] - 1 Module
C5532 .01	Socket 13A International Multi socket Shuttered - 2 Module
C5531 .01	Socket 13A 3-Pin Flat-only Socket Shuttered - 2 Module
C5332 .01	Socket 16A and 6A 3-Pin Shuttered - 2 Module
C5552 .01	Socket 16A and 6A 3-Pin Shuttered - 3 Module
C5331 .01	Socket 16A 3-Pin-only Shuttered - 2 Module
C5732 .01	Socket 25A and 6A 3-Pin Shuttered - 2 Module
C5752 .01	Socket 25A and 6A 3-Pin Shuttered - 3 Module
C5733 .01	Socket 25A 3-Pin-only Shuttered - 2 Module

Fan Regulators & Dimmers Frost White

C5900 .01	Fan Regulator for 80W fan - Step Type with Bar Knob - 2 Module
C5901 .01	Fan Regulator for 80W fan - Step Type with Round Knob - 2 Module
C5910 .01	Fan Regulator for 120W fan - Step Type with Bar Knob - 2 Module
C5911 .01	Fan Regulator for 120W fan - Step Type with Round Knob - 2 Module
C5902 .01	Dimmer 500 Watts - 2 Module
C5903 .01	Dimmer 1000 Watts - 2 Module
C5904 .01	Fan Regulator Single Module for 80W Fan - Step Type - 1 Module
C5905 .01	Dimmer 500 Watts - 1 Module
C5908 .01	Dimmer for LED Lights 100W (3 wire system) - 1 Module
C5909 .01	Dimmer for LED Lights Digital Choke 100W (4 wire system) - 2 Module



C5707 .01
C5708 .01



C5703 .01
C5704 .01
C5705 .01
C5505 .01



C5715 .01
C5716 .01



C5727 .01



C5232 .01

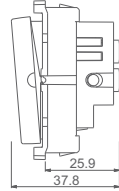

C5706 .01
C5709 .01
C5712 .01



C5460 .01



C5721 .01



C5262 .01
C5263 .01

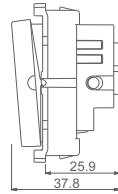

C5711 .01



C5450 .01



C5906 .01



C5233 .01



C5710 .01

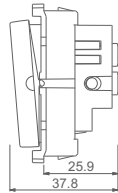

C5718 .01

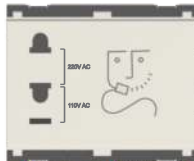

C5723 .01



C5719 .01

CUBE Series

Acoustic & Optical Signaling Frost White

Cat no.	Description
C5707 .01	Electronic Bell - 2 Module
C5727 .01	Indicator Light - 1 Module
C5703 .01	Prismatic Overdoor Bulkhead Indicator - White - 2 Module
C5704 .01	Prismatic Overdoor Bulkhead Indicator - Green - 2 Module
C5705 .01	Prismatic Overdoor Bulkhead Indicator - Red - 2 Module
C5505 .01	Prismatic Overdoor Bulkhead Indicator - Resettable - 2 Module
C5715 .01	Emergency Light - 2 Module
C5706 .01	Speaker for audio music circuit - 2 Module
C5716 .01	Night Light with switch and dimming option - 2 Module
C5721 .01	Step Marker Lamp/ Night Lamp - 2 Module
C5709 .01	Electronic Buzzer - 2 Module
C5710 .01	Electronic Buzzer - 1 Module
C5708 .01	Ultrasonic Mosquito Repellent - 2 Module

29

Hospitality Modules Frost White

C5718 .01	32A Smart Card operated Electronic switch in 3 Module with indicator & exit time delay feature including Smart Card - 3 Module
C5724 .01	Smart Card - Customized
C5719 .01	25A Key Fob Switch Double Pole with indicator - 2 Module
C5720 .01	Key Fob - Customized
C5723 .01	Shaver Socket 220V/110V - 3 Module
C5711 .01	Call Bell Station with Register and provision for External Buzzer - 2M
C5712 .01	External Buzzer for Call Bell Station - 2 Module
C5232 .01	"Do Not Disturb" Switch with indicator - 1 Module
C5233 .01	"Clean My Room" Switch with indicator - 1 Module
C5906 .01	Volume Control 100 Ohms 1 Watt - 2 Module
C5262 .01	Bell Switch with "Do Not Disturb" & "Clean My Room" Indicator - 2M
C5263 .01	Bell Switch with "DND", "CMR" & Guest is in Indicator - 2M
C5450 .01	Push Button station (Start - Stop) - 2 Module
C5460 .01	Curtain Control Switch 6A - 2 Module



C5729 .01



C5739 .01



C5800 .01
C5809 .01



C5701 .01



C5700 .01



C5802 .01
C5803 .01

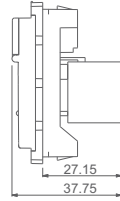

C5725 .01
C5736 .01



C5836 .01



C5797 .01



C5500 .01



C5798 .01



C5820 .01

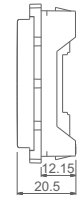

C5936 .01

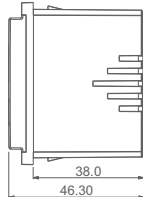

P5131 .01



P5151 .01



P5111 .01

CUBE Series

Communiqué & Support Modules Frost White

Cat no.	Description
C5797 .01	Coaxial T.V Socket - 1 Module
C5725 .01	USB Extension Socket - 1 Module
C5736 .01	USB Charger Socket Outlet A Type - 2.1 Amps - 1 Module
C5836 .01	USB Charger Socket Outlet C Type - 2.1 Amps - 1 Module
C5936 .01	USB Charger Socket Outlet A+C Type - 2.1 Amps - 1 Module
C5729 .01	Computer Monitor Output Socket - 1 Module
C5739 .01	HDMI Socket - 1 Module
C5800 .01	Telephone Socket RJ-11 Double Line Shuttered - 1 Module
C5820 .01	Twin Telephone Socket RJ-11 - 1 Module
C5802 .01	Information Socket 6e - UTP Shuttered - 1 Module
C5803 .01	Information Socket 6a - UTP Shuttered - 1 Module
C5701 .01	Triple RCA Audio Visual Socket - 1 Module
C5500 .01	Cord Outlet - 1 Module
C5700 .01	Blanking Plate - 1 Module
C5798 .01	Audio Port / Jack 3.5mm - 1 Module
C5809 .01	Fitment for RJ-45 Computer Socket Shuttered - 1 Module

31

Plugs Transparent with Dark Gray

P5111 .01	Plug Top 6A with LED indicator
P5131 .01	Plug Top 16A with LED indicator
P5151 .01	Plug Top 25A with LED indicator



V5110 .01
V5210 .01
V5130 .01
V5230 .01



V5111 .01
V5211 .01
V5131 .01
V5231 .01



V5140 .01
V5240 .01
V5160 .01
V5180 .01



V5141 .01
V5241 .01
V5161 .01
V5261 .01



V5281 .01
V5191 .01
V5291 .01
V5171 .01



V5340 .01

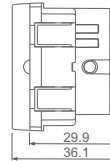

V5341 .01

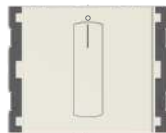

V5900 .01
V5910 .01



V5901 .01
V5911 .01

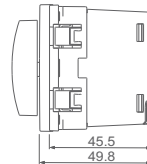

Vertical Switches and Vertical Fan Regulators can be mounted on all types of standard Cube Series Plates. Metal Boxes, Frames and Plates need to be fixed in the vertical position as shown here.

CUBE Series

Vertical Switches Frost White

Cat no.	Description
V5110 .01	Vertical Switches - 2 Gang - Both switches 6A 1 way - 2 Module
V5111 .01	Vertical Switches - 2 Gang - Both switches 6A 1 way with indicator - 2M
V5210 .01	Vertical Switches - 2 Gang - Both switches 6A 2 way - 2 Module
V5211 .01	Vertical Switches - 2 Gang - Both switches 6A 2 way with indicator - 2M
V5130 .01	Vertical Switches - 2 Gang - Both switches 16A 1 way - 2 Module
V5131 .01	Vertical Switches - 2 Gang - Both switches 16A 1 way with indicator - 2M
V5230 .01	Vertical Switches - 2 Gang - Both switches 16A 2 way - 2 Module
V5231 .01	Vertical Switches - 2 Gang - Both switches 16A 2 way with indicator - 2M
V5140 .01	Vertical Palm Switch 6A 1 way Single Pole - 2 Module
V5141 .01	Vertical Palm Switch 6A 1way Single Pole with indicator - 2 Module
V5240 .01	Vertical Palm Switch 6A 2 way Single Pole - 2 Module
V5241 .01	Vertical Palm Switch 6A 2 way Single Pole with indicator - 2 Module
V5160 .01	Vertical Palm Switch 16A 1 way Single Pole - 2 Module
V5161 .01	Vertical Palm Switch 16A 1 way Single Pole with indicator - 2 Module
V5261 .01	Vertical Palm Switch 16A 2 way Single Pole with indicator - 2 Module
V5180 .01	Vertical Palm Switch 6A 1 way Double Pole - 2 Module
V5281 .01	Vertical Palm Switch 6A 2 way Double Pole with indicator - 2 Module
V5191 .01	Vertical Palm Switch 16A 1 way Double Pole with indicator - 2 Module
V5291 .01	Vertical Palm Switch 16A 2 way Double Pole with indicator - 2 Module
V5171 .01	Vertical Palm Switch 25A 1 way Double Pole with indicator - 2 Module
V5340 .01	Vertical Palm Bell Switch Single Pole - 2 Module
V5341 .01	Vertical Palm Bell Switch Single Pole with indicator - 2 Module

33

Vertical Fan Regulators & Dimmers Frost White

V5900 .01	Vertical Fan Regulator for 80W fan - Step Type with Bar Knob - 2M
V5901 .01	Vertical Fan Regulator for 80W fan - Step Type with Round Knob - 2M
V5910 .01	Vertical Fan Regulator for 120W fan - Step Type with Bar Knob - 2M
V5911 .01	Vertical Fan Regulator for 120W fan - Step Type with Round Knob - 2M
V5902 .01	Vertical Dimmer 500 Watts - 2 Module



C5110 .02
C5130 .02
C5730 .02



C5210 .02
C5230 .02



C5310 .02



C5441 .02

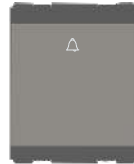

C5340 .02

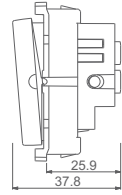

C5111 .02
C5131 .02
C5731 .02



C5211 .02
C5231 .02



C5311 .02



C5431 .02

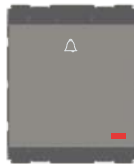

C5341 .02

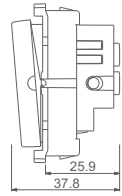

C5140 .02
C5160 .02



C5180 .02

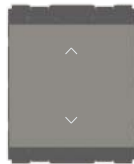

C5240 .02
C5260 .02

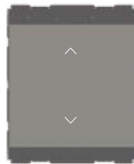

C5280 .02

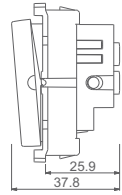

C5141 .02
C5161 .02



C5191 .02
C5171 .02

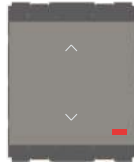

C5241 .02
C5261 .02



C5281 .02
C5291 .02

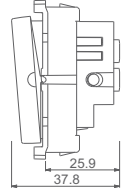

CUBE Series

Switches Quartz Gray

Cat no.	Description
C5110 .02	Switch 6A One-way - 1 Module
C5111 .02	Switch 6A One-way with indicator - 1 Module
C5210 .02	Switch 6A Two-way - 1 Module
C5211 .02	Switch 6A Two-way with indicator - 1 Module
C5130 .02	Switch 16A One-way - 1 Module
C5131 .02	Switch 16A One-way with indicator - 1 Module
C5230 .02	Switch 16A Two-way - 1 Module
C5231 .02	Switch 16A Two-way with indicator - 1 Module
C5730 .02	Switch 25A One-way - 1 Module
C5731 .02	Switch 25A One-way with indicator - 1 Module
C5310 .02	Switch 6A - Bell - 1 Module
C5311 .02	Switch 6A - Bell with indicator - 1 Module
C5140 .02	Palm Switch 6A One-way Single Pole - 2 Module
C5141 .02	Palm Switch 6A One-way Single Pole with indicator - 2 Module
C5240 .02	Palm Switch 6A Two-way Single Pole - 2 Module
C5241 .02	Palm Switch 6A Two-way Single Pole with indicator - 2 Module
C5160 .02	Palm Switch 16A One-way Single Pole - 2 Module
C5161 .02	Palm Switch 16A One-way Single Pole with indicator - 2 Module
C5260 .02	Palm Switch 16A Two-way Single Pole - 2 Module
C5261 .02	Palm Switch 16A Two-way Single Pole with indicator - 2 Module
C5180 .02	Palm Switch 6A One-way Double Pole - 2 Module
C5280 .02	Palm Switch 6A Two-way Double Pole - 2 Module
C5281 .02	Palm Switch 6A Two-way Double Pole with indicator - 2 Module
C5191 .02	Palm Switch 16A One-way Double Pole with indicator - 2 Module
C5291 .02	Palm Switch 16A Two-way Double Pole with indicator - 2 Module
C5171 .02	Palm Switch 25A One-way Double Pole with indicator - 2 Module
C5340 .02	Palm Bell Switch Single Pole - 2 Module
C5341 .02	Palm Bell Switch Single Pole with indicator - 2 Module
C5441 .02	Switch 16A One-way with 'Geyser' Symbol with indicator - 1 Module
C5431 .02	Switch 6A One-way with 'Fan' or 'Light' or 'Exhaust' symbol - 1 Module



C2110.02



C2111.02



C2010.02



C2011.02



C2130.02

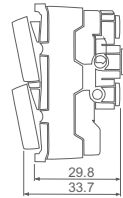

C2131.02



C2030.02



C2031.02



C2140.02



C2141.02

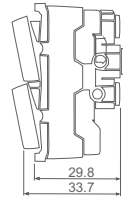

C2040.02



C2041.02

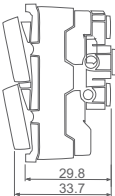

CUBE Series

Twin Switches Quartz Gray

Cat no.	Description
C2110 .02	Twin Switch 6A - 2 Gang - Both switches 1 way - 1 Module
C2111 .02	Twin Switch 6A - 2 Gang - 1 way + 1 way with indicator - 1 Module
C2010 .02	Twin Switch 6A - 1 Gang - 2 way + Dummy - 1 Module
C2011 .02	Twin Switch 6A - 1 Gang - 2 way with indicator + Dummy - 1 Module
C2130 .02	Twin Switch 16A - 2 Gang - Both switches 1 way - 1 Module
C2131 .02	Twin Switch 16A - 2 Gang - 1 way + 1 way with indicator - 1 Module
C2030 .02	Twin Switch 16A - 1 Gang - 2 way + Dummy - 1 Module
C2031 .02	Twin Switch 16A - 1 Gang - 2 way with indicator + Dummy - 1 Module
C2140 .02	Twin Switch 6A - 2 Gang - Both Switches Bell - 1 Module
C2141 .02	Twin Switch 6A - 2 Gang - 1 Bell + 1 Bell with Indicator - 1 Module
C2040 .02	Twin Switch 6A - 1 Gang - 1 Bell + 1 Dummy - 1 Module
C2041 .02	Twin Switch 6A - 1 Gang - 1 Bell with Indicator + 1 Dummy - 1 Module



C5212 .02



C5332 .02



C5732 .02

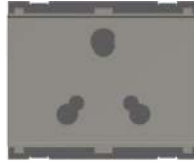

C5552 .02

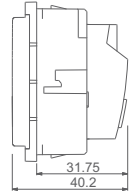

C5532 .02



C5900 .02



C5901 .02

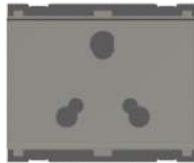

C5752 .02

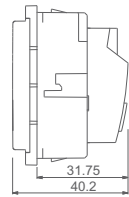

C5902 .02
C5903 .02
C5909 .02

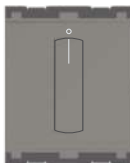

C5910 .02



C5911 .02



C5331 .02
C5733 .02

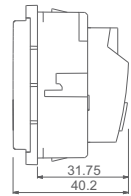

C5010 .02



C5904 .02



C5905 .02
C5908 .02



C5531 .02



C5213 .02

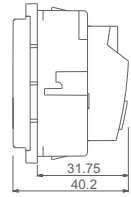

CUBE Series

Sockets Quartz Gray

Cat no.	Description
C5212 .02	Socket 6A 3+2 Pin [Round & Flat] Shuttered - 2 Module
C5213 .02	Socket 6A 3-Pin-only Shuttered - 2 Module
C5010 .02	Socket 6A 2 Pin [Round & Flat] - 1 Module
C5532 .02	Socket 13A International Multi socket Shuttered - 2 Module
C5531 .02	Socket 13A 3-Pin Flat-only Socket Shuttered - 2 Module
C5332 .02	Socket 16A and 6A 3-Pin Shuttered - 2 Module
C5552 .02	Socket 16A and 6A 3-Pin Shuttered - 3 Module
C5331 .02	Socket 16A 3-Pin-only Shuttered - 2 Module
C5732 .02	Socket 25A and 6A 3-Pin Shuttered - 2 Module
C5752 .02	Socket 25A and 6A 3-Pin Shuttered - 3 Module
C5733 .02	Socket 25A 3-Pin-only Shuttered - 2 Module

Fan Regulators & Dimmers Quartz Gray

C5900 .02	Fan Regulator for 80W fan - Step Type with Bar Knob - 2 Module
C5901 .02	Fan Regulator for 80W fan - Step Type with Round Knob - 2 Module
C5910 .02	Fan Regulator for 120W fan - Step Type with Bar Knob - 2 Module
C5911 .02	Fan Regulator for 120W fan - Step Type with Round Knob - 2 Module
C5902 .02	Dimmer 500 Watts - 2 Module
C5903 .02	Dimmer 1000 Watts - 2 Module
C5904 .02	Fan Regulator Single Module for 80W Fan - Step Type - 1 Module
C5905 .02	Dimmer 500 Watts - 1 Module
C5908 .02	Dimmer for LED Lights 100W (3 wire system) - 1 Module
C5909 .02	Dimmer for LED Lights with Digital Choke 100W (4 wire system) - 2M



C5707 .02
C5708 .02



C5703 .01
C5704 .01
C5705 .01
C5505 .01



C5715 .02
C5716 .02



C5727 .02



C5232 .02

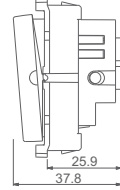

C5706 .02
C5709 .02
C5712 .02



C5460 .02



C5721 .02



C5262 .02
C5263 .02

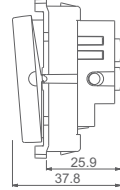

40



C5711 .02



C5450 .02



C5906 .02



C5233 .02



C5710 .02

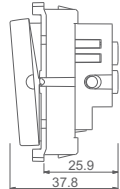

C5718 .02

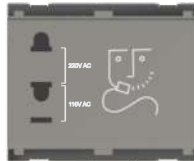

C5723 .02



C5719 .02

CUBE Series

Acoustic & Optical Signaling Quartz Gray

Cat no.	Description
C5707 .02	Electronic Bell - 2 Module
C5727 .02	Indicator Light - 1 Module
C5703 .01	Prismatic Overdoor Bulkhead Indicator - White - 2 Module
C5704 .01	Prismatic Overdoor Bulkhead Indicator - Green - 2 Module
C5705 .01	Prismatic Overdoor Bulkhead Indicator - Red - 2 Module
C5505 .01	Prismatic Overdoor Bulkhead Indicator - Resettable - 2 Module
C5715 .02	Emergency Light - 2 Module
C5706 .02	Speaker for audio music circuit - 2 Module
C5716 .02	Night Light with switch and dimming option - 2 Module
C5721 .02	Step Marker Lamp/ Night Lamp - 2 Module
C5709 .02	Electronic Buzzer - 2 Module
C5710 .02	Electronic Buzzer - 1 Module
C5708 .02	Ultrasonic Mosquito Repellent - 2 Module

41

Hospitality Modules Quartz Gray

C5718 .02	32A Smart Card operated Electronic switch in 3 Module with indicator & exit time delay feature including Smart Card - 3 Module
C5724 .02	Smart Card - Customized
C5719 .02	25A Key Fob Switch Double Pole with indicator - 2 Module
C5720 .02	Key Fob - Customized
C5723 .02	Shaver Socket 220V/110V - 3 Module
C5711 .02	Call Bell Station with Register and provision for External Buzzer - 2M
C5712 .02	External Buzzer for Call Bell Station - 2 Module
C5232 .02	"Do Not Disturb" Switch with indicator - 1 Module
C5233 .02	"Clean My Room" Switch with indicator - 1 Module
C5906 .02	Volume Control 100 Ohms 1 Watt - 2 Module
C5262 .02	Bell Switch with "Do Not Disturb" & "Clean My Room" Indicator - 2M
C5263 .02	Bell Switch with "DND", "CMR" & Guest is in Indicator - 2M
C5450 .02	Push Button station (Start - Stop) - 2 Module
C5460 .02	Curtain Control Switch 6A - 2 Module



C5729 .02



C5739 .02



C5800 .02
C5809 .02



C5701 .02



C5700 .02



C5802 .02
C5803 .02

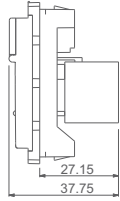

C5725 .02
C5736 .02



C5836 .02



C5797 .02



C5500 .02



C5798 .02



C5820 .02

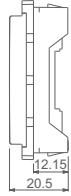

C5936 .02



CUBE Series

Communiqué & Support Modules Quartz Gray

Cat no.	Description
C5797 .02	Coaxial T.V Socket - 1 Module
C5725 .02	USB Extension Socket - 1 Module
C5736 .02	USB Charger Socket Outlet A Type - 2.1 Amps - 1 Module
C5836 .02	USB Charger Socket Outlet C Type - 2.1 Amps - 1 Module
C5936 .02	USB Charger Socket Outlet A+C Type - 2.1 Amps - 1 Module
C5729 .02	Computer Monitor Output Socket - 1 Module
C5739 .02	HDMI Socket - 1 Module
C5800 .02	Telephone Socket RJ-11 Double Line Shuttered - 1 Module
C5820 .02	Twin Telephone Socket RJ-11 - 1 Module
C5802 .02	Information Socket 6e - UTP Shuttered - 1 Module
C5803 .02	Information Socket 6a - UTP Shuttered - 1 Module
C5701 .02	Triple RCA Audio Visual Socket - 1 Module
C5500 .02	Cord Outlet - 1 Module
C5700 .02	Blanking Plate - 1 Module
C5798 .02	Audio Port / Jack 3.5mm - 1 Module
C5809 .02	Fitment for RJ-45 Computer Socket Shuttered - 1 Module



V5110 .02
V5210 .02
V5130 .02
V5230 .02



V5111 .02
V5211 .02
V5131 .02
V5231 .02



V5140 .02
V5240 .02
V5160 .02
V5180 .02



V5141 .02
V5241 .02
V5161 .02
V5261 .02



V5281 .02
V5191 .02
V5291 .02
V5171 .02



V5340 .02

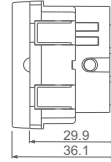

V5341 .02



V5900 .02
V5910 .02



V5901 .02
V5911 .02

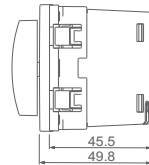

Vertical Switches and Vertical Fan Regulators can be mounted on all types of standard Cube Series Plates. Metal Boxes, Frames and Plates need to be fixed in the vertical position as shown here.

CUBE Series

Vertical Switches Quartz Gray

Cat no.	Description
V5110 .02	Vertical Switches - 2 Gang - Both switches 6A 1 way - 2 Module
V5111 .02	Vertical Switches - 2 Gang - Both switches 6A 1 way with indicator - 2M
V5210 .02	Vertical Switches - 2 Gang - Both switches 6A 2 way - 2 Module
V5211 .02	Vertical Switches - 2 Gang - Both switches 6A 2 way with indicator - 2M
V5130 .02	Vertical Switches - 2 Gang - Both switches 16A 1 way - 2 Module
V5131 .02	Vertical Switches - 2 Gang - Both switches 16A 1 way with indicator - 2M
V5230 .02	Vertical Switches - 2 Gang - Both switches 16A 2 way - 2 Module
V5231 .02	Vertical Switches - 2 Gang - Both switches 16A 2 way with indicator - 2M
V5140 .02	Vertical Palm Switch 6A 1 way Single Pole - 2 Module
V5141 .02	Vertical Palm Switch 6A 1way Single Pole with indicator - 2 Module
V5240 .02	Vertical Palm Switch 6A 2 way Single Pole - 2 Module
V5241 .02	Vertical Palm Switch 6A 2 way Single Pole with indicator - 2 Module
V5160 .02	Vertical Palm Switch 16A 1 way Single Pole - 2 Module
V5161 .02	Vertical Palm Switch 16A 1 way Single Pole with indicator - 2 Module
V5261 .02	Vertical Palm Switch 16A 2 way Single Pole with indicator - 2 Module
V5180 .02	Vertical Palm Switch 6A 1 way Double Pole - 2 Module
V5281 .02	Vertical Palm Switch 6A 2 way Double Pole with indicator - 2 Module
V5191 .02	Vertical Palm Switch 16A 1 way Double Pole with indicator - 2 Module
V5291 .02	Vertical Palm Switch 16A 2 way Double Pole with indicator - 2 Module
V5171 .02	Vertical Palm Switch 25A 1 way Double Pole with indicator - 2 Module
V5340 .02	Vertical Palm Bell Switch Single Pole - 2 Module
V5341 .02	Vertical Palm Bell Switch Single Pole with indicator - 2 Module

45

Vertical Fan Regulators & Dimmers Quartz Gray

V5900 .02	Vertical Fan Regulator for 80W fan - Step Type with Bar Knob - 2M
V5901 .02	Vertical Fan Regulator for 80W fan - Step Type with Round Knob - 2M
V5910 .02	Vertical Fan Regulator for 120W fan - Step Type with Bar Knob - 2M
V5911 .02	Vertical Fan Regulator for 120W fan - Step Type with Round Knob - 2M
V5902 .02	Vertical Dimmer 500 Watts - 2 Module



C5110 .17
C5130 .17
C5730 .17



C5210 .17
C5230 .17



C5310 .17



C5441 .17

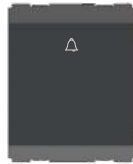

C5340 .17

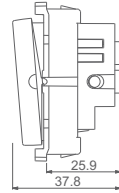

C5111 .17
C5131 .17
C5731 .17



C5211 .17
C5231 .17



C5311 .17



C5431 .17

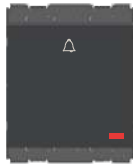

C5341 .17

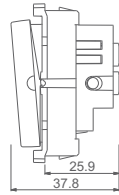

46



C5140 .17
C5160 .17



C5180 .17



C5240 .17
C5260 .17



C5280 .17

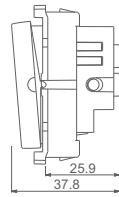

C5141 .17
C5161 .17



C5191 .17
C5171 .17

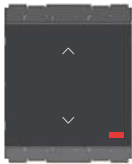

C5241 .17
C5261 .17

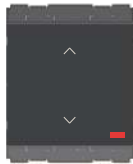

C5281 .17
C5291 .17

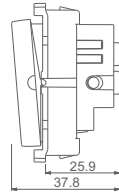

CUBE Series

Switches Charcoal Black

Cat no.	Description
C5110 .17	Switch 6A One-way - 1 Module
C5111 .17	Switch 6A One-way with indicator - 1 Module
C5210 .17	Switch 6A Two-way - 1 Module
C5211 .17	Switch 6A Two-way with indicator - 1 Module
C5130 .17	Switch 16A One-way - 1 Module
C5131 .17	Switch 16A One-way with indicator - 1 Module
C5230 .17	Switch 16A Two-way - 1 Module
C5231 .17	Switch 16A Two-way with indicator - 1 Module
C5730 .17	Switch 25A One-way - 1 Module
C5731 .17	Switch 25A One-way with indicator - 1 Module
C5310 .17	Switch 6A - Bell - 1 Module
C5311 .17	Switch 6A - Bell with indicator - 1 Module
C5140 .17	Palm Switch 6A One-way Single Pole - 2 Module
C5141 .17	Palm Switch 6A One-way Single Pole with indicator - 2 Module
C5240 .17	Palm Switch 6A Two-way Single Pole - 2 Module
C5241 .17	Palm Switch 6A Two-way Single Pole with indicator - 2 Module
C5160 .17	Palm Switch 16A One-way Single Pole - 2 Module
C5161 .17	Palm Switch 16A One-way Single Pole with indicator - 2 Module
C5260 .17	Palm Switch 16A Two-way Single Pole - 2 Module
C5261 .17	Palm Switch 16A Two-way Single Pole with indicator - 2 Module
C5180 .17	Palm Switch 6A One-way Double Pole - 2 Module
C5280 .17	Palm Switch 6A Two-way Double Pole - 2 Module
C5281 .17	Palm Switch 6A Two-way Double Pole with indicator - 2 Module
C5191 .17	Palm Switch 16A One-way Double Pole with indicator - 2 Module
C5291 .17	Palm Switch 16A Two-way Double Pole with indicator - 2 Module
C5171 .17	Palm Switch 25A One-way Double Pole with indicator - 2 Module
C5340 .17	Palm Bell Switch Single Pole - 2 Module
C5341 .17	Palm Bell Switch Single Pole with indicator - 2 Module
C5441 .17	Switch 16A One-way with 'Geyser' Symbol with indicator - 1 Module
C5431 .17	Switch 6A One-way with 'Fan' or 'Light' or 'Exhaust' symbol - 1 Module



C2110.17



C2111.17



C2010.17



C2011.17



C2130.17

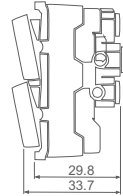

C2131.17



C2030.17



C2031.17



C2140.17



C2141.17

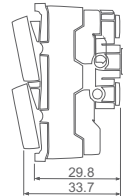

C2040.17



C2041.17

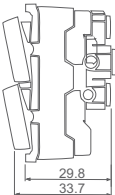

CUBE Series

Twin Switches Charcoal Black

Cat no.	Description
C2110 .17	Twin Switch 6A - 2 Gang - Both switches 1 way - 1 Module
C2111 .17	Twin Switch 6A - 2 Gang - 1 way + 1 way with indicator - 1 Module
C2010 .17	Twin Switch 6A - 1 Gang - 2 way + Dummy - 1 Module
C2011 .17	Twin Switch 6A - 1 Gang - 2 way with indicator + Dummy - 1 Module
C2130 .17	Twin Switch 16A - 2 Gang - Both switches 1 way - 1 Module
C2131 .17	Twin Switch 16A - 2 Gang - 1 way + 1 way with indicator - 1 Module
C2030 .17	Twin Switch 16A - 1 Gang - 2 way + Dummy - 1 Module
C2031 .17	Twin Switch 16A - 1 Gang - 2 way with indicator + Dummy - 1 Module
C2140 .17	Twin Switch 6A - 2 Gang - Both Switches Bell - 1 Module
C2141 .17	Twin Switch 6A - 2 Gang - 1 Bell + 1 Bell with Indicator - 1 Module
C2040 .17	Twin Switch 6A - 1 Gang - 1 Bell + 1 Dummy - 1 Module
C2041 .17	Twin Switch 6A - 1 Gang - 1 Bell with Indicator + 1 Dummy - 1 Module



C5212 .17



C5332 .17



C5732 .17



C5552 .17

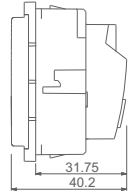

C5532 .17



C5900 .17



C5901 .17



C5752 .17

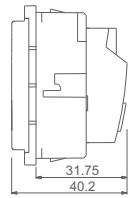

C5902 .17
C5903 .17
C5909 .17



C5910 .17



C5911 .17



C5331 .17
C5733 .17



C5010 .17



C5904 .17



C5905 .17
C5908 .17



C5531 .17



C5213 .17

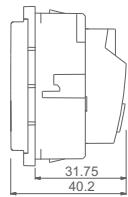

CUBE Series

Sockets Charcoal Black

Cat no.	Description
C5212 .17	Socket 6A 3+2 Pin [Round & Flat] Shuttered - 2 Module
C5213 .17	Socket 6A 3-Pin-only Shuttered - 2 Module
C5010 .17	Socket 6A 2 Pin [Round & Flat] - 1 Module
C5532 .17	Socket 13A International Multi socket Shuttered - 2 Module
C5531 .17	Socket 13A 3-Pin Flat-only Socket Shuttered - 2 Module
C5332 .17	Socket 16A and 6A 3-Pin Shuttered - 2 Module
C5552 .17	Socket 16A and 6A 3-Pin Shuttered - 3 Module
C5331 .17	Socket 16A 3-Pin-only Shuttered - 2 Module
C5732 .17	Socket 25A and 6A 3-Pin Shuttered - 2 Module
C5752 .17	Socket 25A and 6A 3-Pin Shuttered - 3 Module
C5733 .17	Socket 25A 3-Pin-only Shuttered - 2 Module

Fan Regulators & Dimmers Charcoal Black

C5900 .17	Fan Regulator for 80W fan - Step Type with Bar Knob - 2 Module
C5901 .17	Fan Regulator for 80W fan - Step Type with Round Knob - 2 Module
C5910 .17	Fan Regulator for 120W fan - Step Type with Bar Knob - 2 Module
C5911 .17	Fan Regulator for 120W fan - Step Type with Round Knob - 2 Module
C5902 .17	Dimmer 500 Watts - 2 Module
C5903 .17	Dimmer 1000 Watts - 2 Module
C5904 .17	Fan Regulator Single Module for 80W Fan - Step Type - 1 Module
C5905 .17	Dimmer 500 Watts - 1 Module
C5908 .17	Dimmer for LED Lights 100W (3 wire system) - 1 Module
C5909 .17	Dimmer for LED Lights with Digital Choke 100W (4 wire system) - 2M



C5707 .17
C5708 .17



C5703 .01
C5704 .01
C5705 .01
C5505 .01



C5715 .17
C5716 .17



C5727 .17



C5232 .17

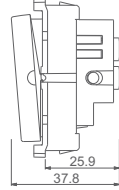

C5706 .17
C5709 .17
C5712 .17



C5460 .17



C5721 .17



C5262 .17
C5263 .17

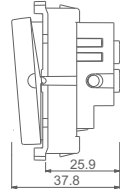

C5711 .17



C5450 .17

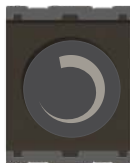

C5906 .17



C5233 .17



C5710 .17

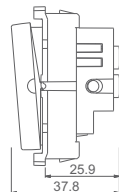

C5718 .17



C5723 .17



C5719 .17

CUBE Series

Acoustic & Optical Signaling Charcoal Black

Cat no.	Description
C5707 .17	Electronic Bell - 2 Module
C5727 .17	Indicator Light - 1 Module
C5703 .01	Prismatic Overdoor Bulkhead Indicator - White - 2 Module
C5704 .01	Prismatic Overdoor Bulkhead Indicator - Green - 2 Module
C5705 .01	Prismatic Overdoor Bulkhead Indicator - Red - 2 Module
C5505 .01	Prismatic Overdoor Bulkhead Indicator - Resettable - 2 Module
C5715 .17	Emergency Light - 2 Module
C5706 .17	Speaker for audio music circuit - 2 Module
C5716 .17	Night Light with switch and dimming option - 2 Module
C5721 .17	Step Marker Lamp/ Night Lamp - 2 Module
C5709 .17	Electronic Buzzer - 2 Module
C5710 .17	Electronic Buzzer - 1 Module
C5708 .17	Ultrasonic Mosquito Repellent - 2 Module

53

Hospitality Modules Charcoal Black

C5718 .17	32A Smart Card operated Electronic switch in 3 Module with indicator & exit time delay feature including Smart Card - 3 Module
C5724 .17	Smart Card - Customized
C5719 .17	25A Key Fob Switch Double Pole with indicator - 2 Module
C5720 .17	Key Fob - Customized
C5723 .17	Shaver Socket 220V/110V - 3 Module
C5711 .17	Call Bell Station with Register and provision for External Buzzer - 2M
C5712 .17	External Buzzer for Call Bell Station - 2 Module
C5232 .17	"Do Not Disturb" Switch with indicator - 1 Module
C5233 .17	"Clean My Room" Switch with indicator - 1 Module
C5906 .17	Volume Control 100 Ohms 1 Watt - 2 Module
C5262 .17	Bell Switch with "Do Not Disturb" & "Clean My Room" Indicator - 2M
C5263 .17	Bell Switch with "DND", "CMR" & Guest is in Indicator - 2M
C5450 .17	Push Button station (Start - Stop) - 2 Module
C5460 .17	Curtain Control Switch 6A - 2 Module



C5809 .17

C5700 .17

C5802 .17
C5803 .17

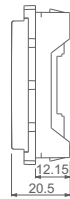

C5725 .17
C5736 .17

C5836 .17

C5797 .17

C5500 .17

C5798 .17

C5820 .17

54



C5936 .17

C5110 .20

C5111 .20

C5131 .20
C5731 .20

C5171 .20

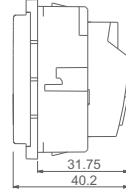

C5212 .20

C5532 .20

C5332 .20

C5732 .20

CUBE Series

Communiqué & Support Modules Charcoal Black

Cat no.	Description
C5797 .17	Coaxial T.V Socket - 1 Module
C5725 .17	USB Extension Socket - 1 Module
C5736 .17	USB Charger Socket Outlet A Type - 2.1 Amps - 1 Module
C5836 .17	USB Charger Socket Outlet C Type - 2.1 Amps - 1 Module
C5936 .17	USB Charger Socket Outlet A+C Type - 2.1 Amps - 1 Module
C5729 .17	Computer Monitor Output Socket - 1 Module
C5739 .17	HDMI Socket - 1 Module
C5800 .17	Telephone Socket RJ-11 Double Line Shuttered - 1 Module
C5820 .17	Twin Telephone Socket RJ-11 - 1 Module
C5802 .17	Information Socket 6e - UTP Shuttered - 1 Module
C5803 .17	Information Socket 6a - UTP Shuttered - 1 Module
C5701 .17	Triple RCA Audio Visual Socket - 1 Module
C5500 .17	Cord Outlet - 1 Module
C5700 .17	Blanking Plate - 1 Module
C5798 .17	Audio Port / Jack 3.5mm - 1 Module
C5809 .17	Fitment for RJ-45 Computer Socket Shuttered - 1 Module

55

Dedicated Modules Scarlet Red

C5110 .20	Switch 6A One-way - 1 Module
C5111 .20	Switch 6A One-way with indicator - 1 Module
C5131 .20	Switch 16A One-way with indicator - 1 Module
C5731 .20	Switch 25A One-way with indicator - 1 Module
C5171 .20	Palm Switch 25A One-way Double Pole with indicator - 2 Module
C5212 .20	Socket 6A 3+2 Pin [Round & Flat] Shuttered - 2 Module
C5532 .20	Socket 13A International Multi socket Shuttered - 2 Module
C5332 .20	Socket 16A and 6A 3-Pin Shuttered - 2 Module
C5732 .20	Socket 25A and 6A 3-Pin Shuttered - 2 Module



V5110 .17
V5210 .17
V5130 .17
V5230 .17



V5111 .17
V5211 .17
V5131 .17
V5231 .17



V5140 .17
V5240 .17
V5160 .17
V5180 .17



V5141 .17
V5241 .17
V5161 .17
V5261 .17



V5281 .17
V5191 .17
V5291 .17
V5171 .17



V5340 .17

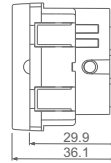

V5341 .17

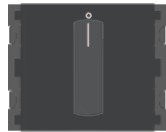

V5900 .17
V5910 .17



V5901 .17
V5911 .17

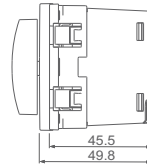

Vertical Switches and Vertical Fan Regulators can be mounted on all types of standard Cube Series Plates. Metal Boxes, Frames and Plates need to be fixed in the vertical position as shown here.

CUBE Series

Vertical Switches Charcoal Black

Cat no.	Description
V5110 .17	Vertical Switches - 2 Gang - Both switches 6A 1 way - 2 Module
V5111 .17	Vertical Switches - 2 Gang - Both switches 6A 1 way with indicator - 2M
V5210 .17	Vertical Switches - 2 Gang - Both switches 6A 2 way - 2 Module
V5211 .17	Vertical Switches - 2 Gang - Both switches 6A 2 way with indicator - 2M
V5130 .17	Vertical Switches - 2 Gang - Both switches 16A 1 way - 2 Module
V5131 .17	Vertical Switches - 2 Gang - Both switches 16A 1 way with indicator - 2M
V5230 .17	Vertical Switches - 2 Gang - Both switches 16A 2 way - 2 Module
V5231 .17	Vertical Switches - 2 Gang - Both switches 16A 2 way with indicator - 2M
V5140 .17	Vertical Palm Switch 6A 1 way Single Pole - 2 Module
V5141 .17	Vertical Palm Switch 6A 1 way Single Pole with indicator - 2 Module
V5240 .17	Vertical Palm Switch 6A 2 way Single Pole - 2 Module
V5241 .17	Vertical Palm Switch 6A 2 way Single Pole with indicator - 2 Module
V5160 .17	Vertical Palm Switch 16A 1 way Single Pole - 2 Module
V5161 .17	Vertical Palm Switch 16A 1 way Single Pole with indicator - 2 Module
V5261 .17	Vertical Palm Switch 16A 2 way Single Pole with indicator - 2 Module
V5180 .17	Vertical Palm Switch 6A 1 way Double Pole - 2 Module
V5281 .17	Vertical Palm Switch 6A 2 way Double Pole with indicator - 2 Module
V5191 .17	Vertical Palm Switch 16A 1 way Double Pole with indicator - 2 Module
V5291 .17	Vertical Palm Switch 16A 2 way Double Pole with indicator - 2 Module
V5171 .17	Vertical Palm Switch 25A 1 way Double Pole with indicator - 2 Module
V5340 .17	Vertical Palm Bell Switch Single Pole - 2 Module
V5341 .17	Vertical Palm Bell Switch Single Pole with indicator - 2 Module

57

Vertical Fan Rgulators & Dimmers Charcoal Black

V5900 .17	Vertical Fan Regulator for 80W fan - Step Type with Bar Knob - 2M
V5901 .17	Vertical Fan Regulator for 80W fan - Step Type with Round Knob - 2M
V5910 .17	Vertical Fan Regulator for 120W fan - Step Type with Bar Knob - 2M
V5911 .17	Vertical Fan Regulator for 120W fan - Step Type with Round Knob - 2M
V5902 .17	Vertical Dimmer 500 Watts - 2 Module



C5101 .01 C5101 .16
 C5101 .02 C5101 .17
 C5101 .03 C5101 .25



C5102 .01 C5102 .16
 C5102 .02 C5102 .17
 C5102 .03 C5102 .25



C5103 .01 C5103 .16
 C5103 .02 C5103 .17
 C5103 .03 C5103 .25

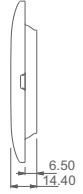

C5104 .01 C5104 .16
 C5104 .02 C5104 .17
 C5104 .03 C5104 .25



C5106 .01 C5106 .16
 C5106 .02 C5106 .17
 C5106 .03 C5106 .25

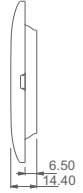

58



C5108 .01 C5108 .16
 C5108 .02 C5108 .17
 C5108 .03 C5108 .25

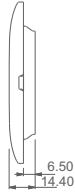

C5109 .01 C5109 .16
 C5109 .02 C5109 .17
 C5109 .03 C5109 .25



C5112 .01 C5112 .16
 C5112 .02 C5112 .17
 C5112 .03 C5112 .25

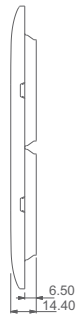

Image for 14M Plate and 21M Plate are not shown here

CUBE Series

Smart plates with frames Frost White, Quartz Gray and Ice Silver

Description	Frost White	Quartz Gray	Ice Silver
	Cat no.	Cat no.	Cat no.
1M Plate	C5101 .01	C5101 .02	C5101 .03
2M Plate	C5102 .01	C5102 .02	C5102 .03
3M Plate	C5103 .01	C5103 .02	C5103 .03
4M Plate	C5104 .01	C5104 .02	C5104 .03
6M Plate	C5106 .01	C5106 .02	C5106 .03
8M Plate	C5108 .01	C5108 .02	C5108 .03
8M (V) Plate	C5109 .01	C5109 .02	C5109 .03
12M Plate	C5112 .01	C5112 .02	C5112 .03
14M Plate	C5114 .01	C5114 .02	C5114 .03
21M Plate	C5121 .01	C5121 .02	C5121 .03

59

Smart plates with frames Matt Gold, Charcoal Black and Cocoa Brown

Description	Matt Gold	Charcoal Black	Cocoa Brown
	Cat no.	Cat no.	Cat no.
1M Plate	C5101 .16	C5101 .17	C5101 .25
2M Plate	C5102 .16	C5102 .17	C5102 .25
3M Plate	C5103 .16	C5103 .17	C5103 .25
4M Plate	C5104 .16	C5104 .17	C5104 .25
6M Plate	C5106 .16	C5106 .17	C5106 .25
8M Plate	C5108 .16	C5108 .17	C5108 .25
8M (V) Plate	C5109 .16	C5109 .17	C5109 .25
12M Plate	C5112 .16	C5112 .17	C5112 .25
14M Plate	C5114 .16	C5114 .17	C5114 .25
21M Plate	C5121 .16	C5121 .17	C5121 .25

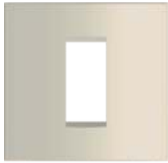

C5401 .01 C5401 .16
 C5401 .02 C5401 .17
 C5401 .03 C5401 .25

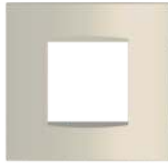

C5402 .01 C5402 .16
 C5402 .02 C5402 .17
 C5402 .03 C5402 .25



C5403 .01 C5403 .16
 C5403 .02 C5403 .17
 C5403 .03 C5403 .25

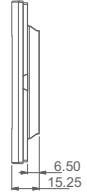

C5404 .01 C5404 .16
 C5404 .02 C5404 .17
 C5404 .03 C5404 .25



C5406 .01 C5406 .16
 C5406 .02 C5406 .17
 C5406 .03 C5406 .25

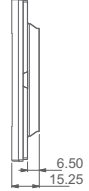

60



C5408 .01 C5408 .16
 C5408 .02 C5408 .17
 C5408 .03 C5408 .25

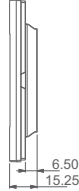

C5409 .01 C5409 .16
 C5409 .02 C5409 .17
 C5409 .03 C5409 .25

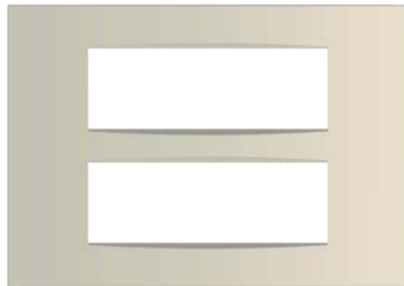

C5412 .01 C5412 .16
 C5412 .02 C5412 .17
 C5412 .03 C5412 .25

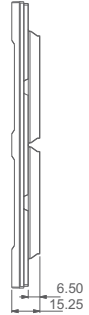

Images for 14M Plate, 16M Plate and 21M Plate are not shown here

CUBE Series

Vector plates with frames Frost White, Quartz Gray and Ice Silver

Description	Frost White	Quartz Gray	Ice Silver
	Cat no.	Cat no.	Cat no.
1M Plate	C5401 .01	C5401 .02	C5401 .03
2M Plate	C5402 .01	C5402 .02	C5402 .03
3M Plate	C5403 .01	C5403 .02	C5403 .03
4M Plate	C5404 .01	C5404 .02	C5404 .03
6M Plate	C5406 .01	C5406 .02	C5406 .03
8M Plate	C5408 .01	C5408 .02	C5408 .03
8M (V) Plate	C5409 .01	C5409 .02	C5409 .03
12M Plate	C5412 .01	C5412 .02	C5412 .03
14M Plate	C5414 .01	C5414 .02	C5414 .03
16M Plate	C5416 .01	C5416 .02	C5416 .03
21M Plate	C5421 .01	C5421 .02	C5421 .03

61

Vector plates with frames Matt Gold, Charcoal Black and Cocoa Brown

Description	Matt Gold	Charcoal Black	Cocoa Brown
	Cat no.	Cat no.	Cat no.
1M Plate	C5401 .16	C5401 .17	C5401 .25
2M Plate	C5402 .16	C5402 .17	C5402 .25
3M Plate	C5403 .16	C5403 .17	C5403 .25
4M Plate	C5404 .16	C5404 .17	C5404 .25
6M Plate	C5406 .16	C5406 .17	C5406 .25
8M Plate	C5408 .16	C5408 .17	C5408 .25
8M (V) Plate	C5409 .16	C5409 .17	C5409 .25
12M Plate	C5412 .16	C5412 .17	C5412 .25
14M Plate	C5414 .16	C5414 .17	C5414 .25
16M Plate	C5416 .16	C5416 .17	C5416 .25
21M Plate	C5421 .16	C5421 .17	C5421 .25



C6401 .01 C6401 .17
 C6401 .02 C6401 .25
 C6401 .03 C6401 .26
 C6401 .16



C6402 .01 C6402 .17
 C6402 .02 C6402 .25
 C6402 .03 C6402 .26
 C6402 .16



C6403 .01 C6403 .17
 C6403 .02 C6403 .25
 C6403 .03 C6403 .26
 C6403 .16

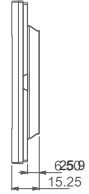

C6404 .01 C6404 .17
 C6404 .02 C6404 .25
 C6404 .03 C6404 .26
 C6404 .16



C6406 .01 C6406 .17
 C6406 .02 C6406 .25
 C6406 .03 C6406 .26
 C6406 .16

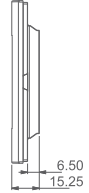

62



C6408 .01 C6408 .17
 C6408 .02 C6408 .25
 C6408 .03 C6408 .26
 C6408 .16

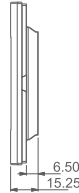

C6409 .01 C6409 .17
 C6409 .02 C6409 .25
 C6409 .03 C6409 .26
 C6409 .16



C6412 .01 C6412 .17
 C6412 .02 C6412 .25
 C6412 .03 C6412 .26
 C6412 .16

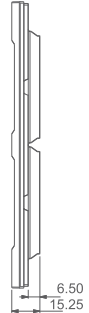

Images for 14M Plate, 16M Plate and 21M Plate are not shown here

CUBE Series

Flat 5 plates with frames Frost White, Quartz Gray and Ice Silver

Description	Frost White	Quartz Gray	Ice Silver	Matt Gold
	Cat no.	Cat no.	Cat no.	Cat no.
1M Plate	C6401 .01	C6401 .02	C6401 .03	C6401 .16
2M Plate	C6402 .01	C6402 .02	C6402 .03	C6402 .16
3M Plate	C6403 .01	C6403 .02	C6403 .03	C6403 .16
4M Plate	C6404 .01	C6404 .02	C6404 .03	C6404 .16
6M Plate	C6406 .01	C6406 .02	C6406 .03	C6406 .16
8M Plate	C6408 .01	C6408 .02	C6408 .03	C6408 .16
8M (V) Plate	C6409 .01	C6409 .02	C6409 .03	C6409 .16
12M Plate	C6412 .01	C6412 .02	C6412 .03	C6412 .16
14M Plate	C6414 .01	C6414 .02	C6414 .03	C6414 .16
16M Plate	C6416 .01	C6416 .02	C6416 .03	C6416 .16
21M Plate	C6421 .01	C6421 .02	C6421 .03	C6421 .16

63

Flat 5 plates with frames Charcoal Black, Cocoa Brown and Silver Dust

Description	Charcoal Black	Cocoa Brown	Silver Dust
	Cat no.	Cat no.	Cat no.
1M Plate	C6401 .17	C6401 .25	C6401 .26
2M Plate	C6402 .17	C6402 .25	C6402 .26
3M Plate	C6403 .17	C6403 .25	C6403 .26
4M Plate	C6404 .17	C6404 .25	C6404 .26
6M Plate	C6406 .17	C6406 .25	C6406 .26
8M Plate	C6408 .17	C6408 .25	C6408 .26
8M (V) Plate	C6409 .17	C6409 .25	C6409 .26
12M Plate	C6412 .17	C6412 .25	C6412 .26
14M Plate	C6414 .17	C6414 .25	C6414 .26
16M Plate	C6416 .17	C6416 .25	C6416 .26
21M Plate	C6421 .17	C6421 .25	C6421 .26

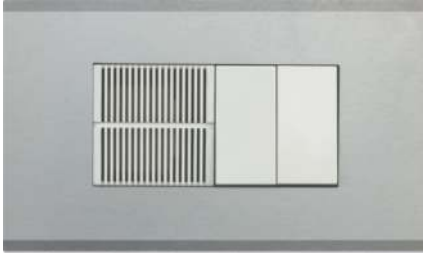

CA304 .04
Solid Aluminum Plate - 4 Module
natural finish mounted with
modules C5706 .01 and C5110 .01

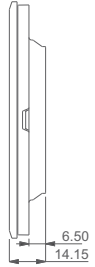

CA304 .05
Solid Aluminum Plate - 4 Module
black finish mounted with
C5706 .02, C5701 .02, C5726 .02

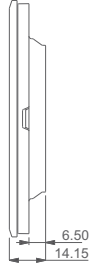

64



CA304 .14
Solid Aluminum Plate - 4 Module
Dark Bronze mounted with
modules C5110 .02 and C5721 .02

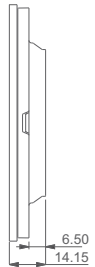

CUBE Series

Solid Aluminum Plates with frames Natural & Black

Description	Aluminum Natural	Aluminum Black
	Cat no.	Cat no.
1M Plate - for 75mm x 75mm box (3x3)	CA301 .04	CA301 .05
2M Plate - for 75mm x 75mm box (3x3)	CA302 .04	CA302 .05
3M Plate - for 100mm x 75mm box (4x3)	CA303 .04	CA303 .05
4M Plate - for 135mm x 75mm box (5x3)	CA304 .04	CA304 .05
6M Plate - for 210mm x 75mm box (8x3)	CA306 .04	CA306 .05
8M Plate - for 230/210 x 75mm box (9x3 or 8x3)	CA308 .04	CA308 .05
8M (V) Plate - for 135mm x 140mm box (5x5)	CA309 .04	CA309 .05
12M Plate - for 140mm x 210mm box (8x6)	CA312 .04	CA312 .05
14M Plate - for 140mm x 210mm box (8x6)	CA314 .04	CA314 .05
16M Plate - for 230x145mm box (10x6 or 9x6)	CA316 .04	CA316 .05
21M Plate - for 210mm x 210mm box (8x8)	CA321 .04	CA321 .05

65

Solid Aluminum Plates with frames Dark Bronze

Description	Dark Bronze
	Cat no.
1M Plate - for 75mm x 75mm box (3x3)	CA301 .14
2M Plate - for 75mm x 75mm box (3x3)	CA302 .14
3M Plate - for 100mm x 75mm box (4x3)	CA303 .14
4M Plate - for 135mm x 75mm box (5x3)	CA304 .14
6M Plate - for 210mm x 75mm box (8x3)	CA306 .14
8M Plate - for 230/210 x 75mm box (9x3 or 8x3)	CA308 .14
8M (V) Plate - for 135mm x 140mm box (5x5)	CA309 .14
12M Plate - for 140mm x 210mm box (8x6)	CA312 .14
14M Plate - for 140mm x 210mm box (8x6)	CA314 .14
16M Plate - for 230x145mm box (10x6 or 9x6)	CA316 .14
21M Plate - for 210mm x 210mm box (8x8)	CA321 .14

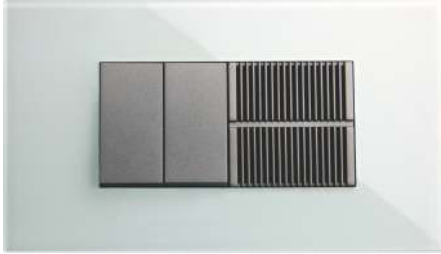

CG304 .08
Solid Glass Plate - 4 Module
ice white finish mounted with
modules C5110 .02 and C5706 .02

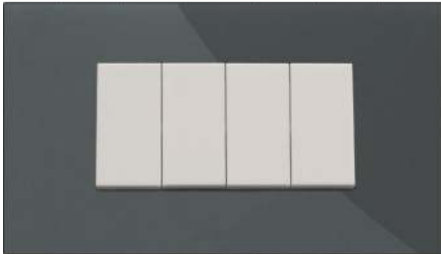
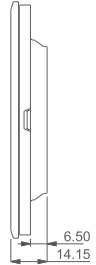

CG304 .09
Solid Glass Plate - 4 Module
metal gray finish mounted with
modules C5110 .01

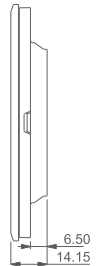

CG304 .18
Solid Glass Plate - 4 Module
Smoked Silver mounted with
modules C5110 .02 and C5212 .02

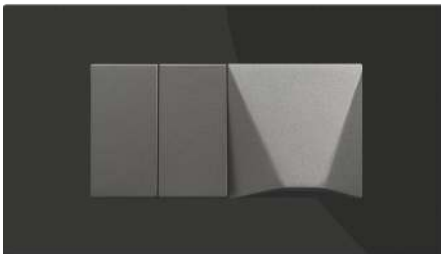
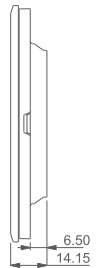

CG304 .19
Solid Glass Plate - 4 Module
Solid Black mounted with
modules C5110 .02 and C5721 .02

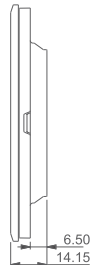

CUBE Series

Solid Glass Plates with frames Ice White & Metal Gray

Description	Ice White	Metal Gray
	Cat no.	Cat no.
1M Plate - for 75mm x 75mm box (3x3)	CG301 .08	CG301 .09
2M Plate - for 75mm x 75mm box (3x3)	CG302 .08	CG302 .09
3M Plate - for 100mm x 75mm box (4x3)	CG303 .08	CG303 .09
4M Plate - for 135mm x 75mm box (5x3)	CG304 .08	CG304 .09
6M Plate - for 210mm x 75mm box (8x3)	CG306 .08	CG306 .09
8M Plate - for 230/210 x 75 mm x (9x3 or 8x3)	CG308 .08	CG308 .09
8M (V) Plate - for 135mm x 140mm box (5x5)	CG309 .08	CG309 .09
12M Plate - for 140mm x 210mm box (8x6)	CG312 .08	CG312 .09
14M Plate - for 140mm x 210mm box (8x6)	CG314 .08	CG314 .09
16M Plate - for 230x145mm box (10x6 or 9x6)	CG316 .08	CG316 .09
21M Plate - for 210mm x 210mm box (8x8)	CG321 .08	CG321 .09

67

Solid Glass Plates with frames Smoked Silver, Solid Black & Ultra White

Description	Smoked Silver	Solid Black	Ultra White
	Cat no.	Cat no.	Cat no.
1M Plate	CG301 .18	CG301 .19	CG301 .38
2M Plate	CG302 .18	CG302 .19	CG302 .38
3M Plate	CG303 .18	CG303 .19	CG303 .38
4M Plate	CG304 .18	CG304 .19	CG304 .38
6M Plate	CG306 .18	CG306 .19	CG306 .38
8M Plate	CG308 .18	CG308 .19	CG308 .38
8M (V) Plate	CG309 .18	CG309 .19	CG309 .38
12M Plate	CG312 .18	CG312 .19	CG312 .38
14M Plate	CG314 .18	CG314 .19	CG314 .38
16M Plate	CG316 .18	CG316 .19	CG316 .38
21M Plate	CG321 .18	CG321 .19	CG321 .38



CM304 .10
Solid Marble Finish Plate - 4 Module
Sparkle White finish mounted with
modules C5715 .01 and C5721 .01

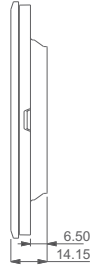

CM304 .11
Solid Marble Finish Plate - 4 Module
Terra Beige finish mounted with
modules C5110 .01 and C5900 .01

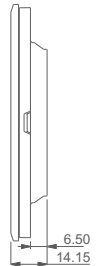

CM304 .12
Solid Marble Finish Plate - 4 Module
Salt White finish mounted with
modules C5739 .02 and C5723 .02

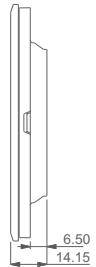

CM304 .13
Solid Marble Finish Plate - 4 Module
Onyx White finish mounted with
modules C5110 .02 and C5721 .02

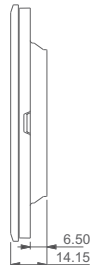

CUBE Series

Solid Marble Finish Plates with frames Sparkle White & Terra Beige

Description	Sparkle White	Terra Beige
	Cat no.	Cat no.
1M Plate - for 75mm x 75mm box (3x3)	CM301 .10	CM301 .11
2M Plate - for 75mm x 75mm box (3x3)	CM302 .10	CM302 .11
3M Plate - for 100mm x 75mm box (4x3)	CM303 .10	CM303 .11
4M Plate - for 135mm x 75mm box (5x3)	CM304 .10	CM304 .11
6M Plate - for 210mm x 75mm box (8x3)	CM306 .10	CM306 .11
8M Plate - for 230/210 x 75mm box (9x3 or 8x3)	CM308 .10	CM308 .11
8M (V) Plate - for 135mm x 140mm box (5x5)	CM309 .10	CM309 .11
12M Plate - for 140mm x 210mm box (8x6)	CM312 .10	CM312 .11
14M Plate - for 140mm x 210mm box (8x6)	CM314 .10	CM314 .11
16M Plate - for 230x145mm box (10x6 or 9x6)	CM316 .10	CM316 .11
21M Plate - for 210mm x 210mm box (8x8)	CM321 .10	CM321 .11

69

Solid Marble Finish Plates with frames Salt White & Onyx White

Description	Salt White	Onyx White
	Cat no.	Cat no.
1M Plate - for 75mm x 75mm box (3x3)	CM301 .12	CM301 .13
2M Plate - for 75mm x 75mm box (3x3)	CM302 .12	CM302 .13
3M Plate - for 100mm x 75mm box (4x3)	CM303 .12	CM303 .13
4M Plate - for 135mm x 75mm box (5x3)	CM304 .12	CM304 .13
6M Plate - for 210mm x 75mm box (8x3)	CM306 .12	CM306 .13
8M Plate - for 230/210 x 75mm box (9x3 or 8x3)	CM308 .12	CM308 .13
8M (V) Plate - for 135mm x 140mm box (5x5)	CM309 .12	CM309 .13
12M Plate - for 140mm x 210mm box (8x6)	CM312 .12	CM312 .13
14M Plate - for 140mm x 210mm box (8x6)	CM314 .12	CM314 .13
16M Plate - for 230x145mm box (10x6 or 9x6)	CM316 .12	CM316 .13
21M Plate - for 210mm x 210mm box (8x8)	CM321 .12	CM321 .13



CW304 .06
 Solid Wood Plate - 4 Module
 dark mahogany mounted with
 modules C5110 .02 and C5721 .02

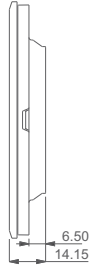

CW304 .07
 Solid Wood Plate - 4 Module
 natural pinewood mounted with
 modules C5110 .01 and C5900 .01

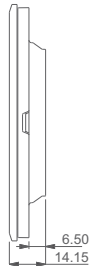

CW304 .29
 Solid Wood Plate - 4 Module
 walnut mounted with
 modules C5110 .02 and C5212 .02

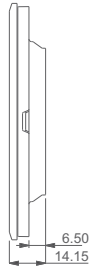

CUBE Series

Solid Wood Plates with frames Dark Mahogany & Natural Pinewood Polish

Description	Dark Mahogany	Pinewood
	Cat no.	Cat no.
1M Plate - for 75mm x 75mm box (3x3)	CW301 .06	CW301 .07
2M Plate - for 75mm x 75mm box (3x3)	CW302 .06	CW302 .07
3M Plate - for 100mm x 75mm box (4x3)	CW303 .06	CW303 .07
4M Plate - for 135mm x 75mm box (5x3)	CW304 .06	CW304 .07
6M Plate - for 210mm x 75mm box (8x3)	CW306 .06	CW306 .07
8M Plate - for 230/210 x 75mm box (9x3 or 8x3)	CW308 .06	CW308 .07
8M (V) Plate - for 135mm x 140mm box (5x5)	CW309 .06	CW309 .07
12M Plate - for 140mm x 210mm box (8x6)	CW312 .06	CW312 .07
14M Plate - for 140mm x 210mm box (8x6)	CW314 .06	CW314 .07
16M Plate - for 230x145mm box (10x6 or 9x6)	CW316 .06	CW316 .07
21M Plate - for 210mm x 210mm box (8x8)	CW321 .06	CW321 .07

71

Solid Wood Plates with frames Walnut Polish

Description	Walnut
	Cat no.
1M Plate - for 75mm x 75mm box (3x3)	CW301 .29
2M Plate - for 75mm x 75mm box (3x3)	CW302 .29
3M Plate - for 100mm x 75mm box (4x3)	CW303 .29
4M Plate - for 135mm x 75mm box (5x3)	CW304 .29
6M Plate - for 210mm x 75mm box (8x3)	CW306 .29
8M Plate - for 230/210 x 75mm box (9x3 or 8x3)	CW308 .29
8M (V) Plate - for 135mm x 140mm box (5x5)	CW309 .29
12M Plate - for 140mm x 210mm box (8x6)	CW312 .29
14M Plate - for 140mm x 210mm box (8x6)	CW314 .29
16M Plate - for 230x145mm box (10x6 or 9x6)	CW316 .29
21M Plate - for 210mm x 210mm box (8x8)	CW321 .29



D5212 .01



D5532 .01



D5531 .01



D5332 .01
D5732 .01



D5212 .02



D5532 .02



D5531 .02



D5332 .02
D5732 .02



D5212 .17

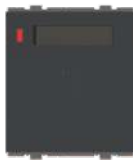

D5532 .17



D5531 .17



D5332 .17
D5732 .17

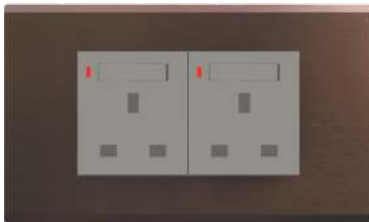

Integral Sockets can only be mounted on Special Flat'5 Plates suitable for mounting Integral Sockets. These plates are available in 2M & 4M sizes only. Colour options available in these plates are listed on the next page.

CUBE Series

Integral Sockets Frost White

Cat no.	Description
D5212 .01	Integral Socket with Switch 6A 3+2 Pin [Round & Flat] Shuttered - 2M
D5532 .01	Integral Socket with Switch 13A International Multi Socket Shuttered - 2M
D5531 .01	Integral Socket with Switch 13A 3-Pin Flat Only Socket Shuttered - 2M
D5332 .01	Integral Socket with Switch 16A/6A 3-Pin Shuttered - 2 Module
D5732 .01	Integral Socket with Switch 25A/6A 3-Pin Shuttered - 2 Module

Integral Sockets Quartz Gray

Cat no.	Description
D5212 .02	Integral Socket with Switch 6A 3+2 Pin [Round & Flat] Shuttered - 2M
D5532 .02	Integral Socket with Switch 13A International Multi Socket Shuttered - 2M
D5531 .02	Integral Socket with Switch 13A 3-Pin Flat Only Socket Shuttered - 2M
D5332 .02	Integral Socket with Switch 16A/6A 3-Pin Shuttered - 2 Module
D5732 .02	Integral Socket with Switch 25A/6A 3-Pin Shuttered - 2 Module

73

Integral Sockets Charcoal Black

Cat no.	Description
D5212 .17	Integral Socket with Switch 6A 3+2 Pin [Round & Flat] Shuttered - 2M
D5532 .17	Integral Socket with Switch 13A International Multi Socket Shuttered - 2M
D5531 .17	Integral Socket with Switch 13A 3-Pin Flat Only Socket Shuttered - 2M
D5332 .17	Integral Socket with Switch 16A/6A 3-Pin Shuttered - 2 Module
D5732 .17	Integral Socket with Switch 25A/6A 3-Pin Shuttered - 2 Module

Flat'5 Plates Suitable for Integral Sockets

D6402 .01	2M Plate - for 93mm x 95mm box (3x3) - Frost White
D6404 .01	4M Plate - for 93mm x 158mm box (3x5) - Frost White
D6402 .02	2M Plate - for 93mm x 95mm box (3x3) - Quartz Gray
D6404 .02	4M Plate - for 93mm x 158mm box (3x5) - Quartz Gray



D6402 .01	DG302 .09
D6402 .02	DG302 .18
D6402 .03	DG302 .19
D6402 .16	DG302 .38
D6402 .17	DM302 .10
D6402 .25	DM302 .11
DA302 .04	DM302 .12
DA302 .05	DM302 .13
DA302 .14	DW302 .06
DG302 .08	DW302 .07

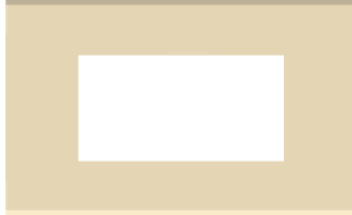

D6404 .01	DG304 .09
D6404 .02	DG304 .18
D6404 .03	DG304 .19
D6404 .16	DG304 .38
D6404 .17	DM304 .10
D6404 .25	DM304 .11
DA304 .04	DM304 .12
DA304 .05	DM304 .13
DA304 .14	DW304 .06
DG304 .08	DW304 .07

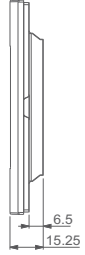

CUBE Series

contd...

D6402 .03	2M Plate - for 93mm x 95mm box (3x3) - Ice Silver
D6404 .03	4M Plate - for 93mm x 158mm box (3x5) - Ice Silver
D6402 .16	2M Plate - for 93mm x 95mm box (3x3) - Matt Gold
D6404 .16	4M Plate - for 93mm x 158mm box (3x5) - Matt Gold
D6402 .17	2M Plate - for 93mm x 95mm box (3x3) - Charcoal Black
D6404 .17	4M Plate - for 93mm x 158mm box (3x5) - Charcoal Black
D6402 .25	2M Plate - for 93mm x 95mm box (3x3) - Cocoa Brown
D6404 .25	4M Plate - for 93mm x 158mm box (3x5) - Cocoa Brown
DA302 .04	2M Plate - for 93mm x 95mm box (3x3) - Solid Aluminum Natural
DA304 .04	4M Plate - for 93mm x 158mm box (3x5) - Solid Aluminum Natural
DA302 .05	2M Plate - for 93mm x 95mm box (3x3) - Solid Aluminum Black
DA304 .05	4M Plate - for 93mm x 158mm box (3x5) - Solid Aluminum Black
DA302 .14	2M Plate - for 93mm x 95mm box (3x3) - Solid Aluminum Dark Bronze
DA304 .14	4M Plate - for 93mm x 158mm box (3x5) - Solid Aluminum Dark Bronze
DG302 .08	2M Plate - for 93mm x 95mm box (3x3) - Solid Glass Ice White
DG304 .08	4M Plate - for 93mm x 158mm box (3x5) - Solid Glass Ice White
DG302 .09	2M Plate - for 93mm x 95mm box (3x3) - Solid Glass Metal Gray
DG304 .09	4M Plate - for 93mm x 158mm box (3x5) - Solid Glass Metal Gray
DG302 .18	2M Plate - for 93mm x 95mm box (3x3) - Solid Glass Smoked Silver
DG304 .18	4M Plate - for 93mm x 158mm box (3x5) - Solid Glass Smoked Silver
DG302 .19	2M Plate - for 93mm x 95mm box (3x3) - Solid Glass Solid Black
DG304 .19	4M Plate - for 93mm x 158mm box (3x5) - Solid Glass Solid Black
DG302 .38	2M Plate - for 93mm x 95mm box (3x3) - Solid Glass Ultra White
DG304 .38	4M Plate - for 93mm x 158mm box (3x5) - Solid Glass Ultra White
DM302 .10	2M Plate - for 93mm x 95mm box (3x3) - Marble Finish Sparkle White
DM304 .10	4M Plate - for 93mm x 158mm box (3x5) - Marble Finish Sparkle White
DM302 .11	2M Plate - for 93mm x 95mm box (3x3) - Marble Finish Terra Beige
DM304 .11	4M Plate - for 93mm x 158mm box (3x5) - Marble Finish Terra Beige
DM302 .12	2M Plate - for 93mm x 95mm box (3x3) - Marble Finish Salt White
DM304 .12	4M Plate - for 93mm x 158mm box (3x5) - Marble Finish Salt White
DM302 .13	2M Plate - for 93mm x 95mm box (3x3) - Marble Finish Onix White
DM304 .13	4M Plate - for 93mm x 158mm box (3x5) - Marble Finish Onix White
DW302 .06	2M Plate - for 93mm x 95mm box (3x3) - Solid Wood Dark Mahagony
DW304 .06	4M Plate - for 93mm x 158mm box (3x5) - Solid Wood Dark Mahagony
DW302 .07	2M Plate - for 93mm x 95mm box (3x3) - Solid Natural Pinewood
DW304 .07	4M Plate - for 93mm x 158mm box (3x5) - Solid Natural Pinewood



C525A .01

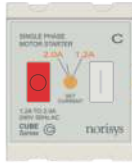

C525C .01

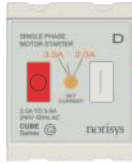

C525D .01



C525E .01



C525F .01



C525G .01



C525H .01



C525J .01



CTTSP06 .01



CTTSP10 .01



CTTSP16 .01



CTTSP20 .01



CTTSP25 .01



CTTSP32 .01

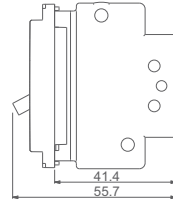

CTTDP06 .01
CTTDP10 .01



CTTDP16 .01
CTTDP20 .01



CTTDP25 .01
CTTDP32 .01



CLBBDP32 .01
CLBBDP50 .01

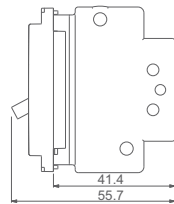

CUBE Series

Single Phase Motor Starters Frost White - for mounting with CUBE Series

Cat no.	Description
C525A .01	Motor Starter 0.60 A - 1.00 A 1/8 HP Pump
C525B .01	Motor Starter 0.90 A - 1.50 A 1/4 HP Pump
C525C .01	Motor Starter 1.20 A - 2.00 A 1/3 HP Pump
C525D .01	Motor Starter 2.00 A - 3.50 A 1/2 HP Pump
C525E .01	Motor Starter 3.00 A - 5.00 A 3/4 HP Pump
C525F .01	Motor Starter 4.75 A - 7.50 A 1 Ton AC
C525G .01	Motor Starter 7.00 A - 11.50 A 1.5 Ton AC
C525H .01	Motor Starter 11.00 A - 18.00 A 2 Ton AC
C525J .01	Motor Starter 16.00 A - 25.00 A 2.5 Ton AC

Tiny MCB Frost White - for mounting with CUBE Series

77

CTTSP06 .01	Tiny MCB Single Pole 6A
CTTSP10 .01	Tiny MCB Single Pole 10A
CTTSP16 .01	Tiny MCB Single Pole 16A
CTTSP20 .01	Tiny MCB Single Pole 20A
CTTSP25 .01	Tiny MCB Single Pole 25A
CTTSP32 .01	Tiny MCB Single Pole 32A
CTTDP06 .01	Tiny MCB Double Pole 6A
CTTDP10 .01	Tiny MCB Double Pole 10A
CTTDP16 .01	Tiny MCB Double Pole 16A
CTTDP20 .01	Tiny MCB Double Pole 20A
CTTDP25 .01	Tiny MCB Double Pole 25A
CTTDP32 .01	Tiny MCB Double Pole 32A

Tiny Load Break Switch Frost White - for mounting with CUBE Series

CLBDP32 .01	Tiny Load Break Switch Double Pole 32A
CLBDP50 .01	Tiny Load Break Switch Double Pole 50A

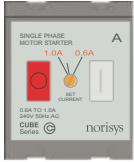

C525A .02

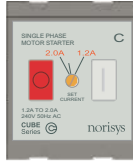

C525C .02

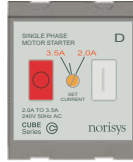

C525D .02

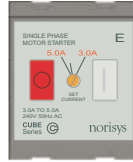

C525E .02

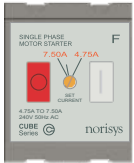
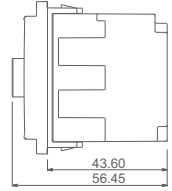

C525F .02

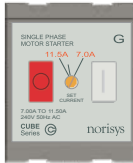

C525G .02

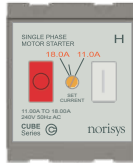

C525H .02

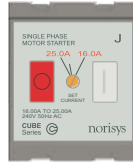

C525J .02

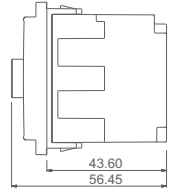

CTTSP06 .02



CTTSP10 .02



CTTSP16 .02



CTTSP20 .02



CTTSP25 .02



CTTSP32 .02

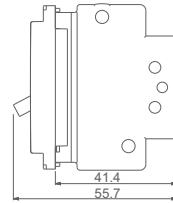

CTTDP06 .02
CTTDP10 .02



CTTDP16 .02
CTTDP20 .02



CTTDP25 .02
CTTDP32 .02



CLBDP32 .02
CLBDP50 .02

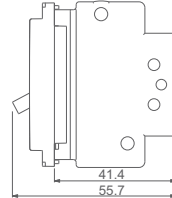

CUBE Series

Single Phase Motor Starters Quartz Gray - for mounting with CUBE Series

Cat no.	Description	
C525A .02	Motor Starter 0.60 A - 1.00 A	1/8 HP Pump
C525B .02	Motor Starter 0.90 A - 1.50 A	1/4 HP Pump
C525C .02	Motor Starter 1.20 A - 2.00 A	1/3 HP Pump
C525D .02	Motor Starter 2.00 A - 3.50 A	1/2 HP Pump
C525E .02	Motor Starter 3.00 A - 5.00 A	3/4 HP Pump
C525F .02	Motor Starter 4.75 A - 7.50 A	1 Ton AC
C525G .02	Motor Starter 7.00 A - 11.50 A	1.5 Ton AC
C525H .02	Motor Starter 11.00 A - 18.00 A	2 Ton AC
C525J .02	Motor Starter 16.00 A - 25.00 A	2.5 Ton AC

Tiny MCB Quartz Gray - for mounting with CUBE Series

CTTSP06 .02	Tiny MCB Single Pole 6A
CTTSP10 .02	Tiny MCB Single Pole 10A
CTTSP16 .02	Tiny MCB Single Pole 16A
CTTSP20 .02	Tiny MCB Single Pole 20A
CTTSP25 .02	Tiny MCB Single Pole 25A
CTTSP32 .02	Tiny MCB Single Pole 32A
CTTDP06 .02	Tiny MCB Double Pole 6A
CTTDP10 .02	Tiny MCB Double Pole 10A
CTTDP16 .02	Tiny MCB Double Pole 16A
CTTDP20 .02	Tiny MCB Double Pole 20A
CTTDP25 .02	Tiny MCB Double Pole 25A
CTTDP32 .02	Tiny MCB Double Pole 32A

Tiny Load Break Switch Quartz Gray - for mounting with CUBE Series

CLBDP32 .02	Tiny Load Break Switch Double Pole 32A
CLBDP50 .02	Tiny Load Break Switch Double Pole 50A

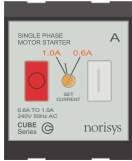

C525A .17

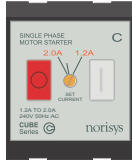

C525C .17

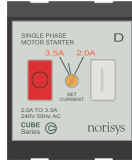

C525D .17

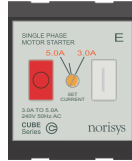

C525E .17

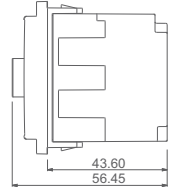

C525F .17



C525G .17



C525H .17

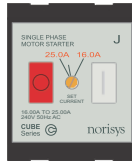

C525J .17

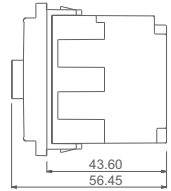

CTTSP06 .17



CTTSP10 .17



CTTSP16 .17



CTTSP20 .17



CTTSP25 .17



CTTSP32 .17

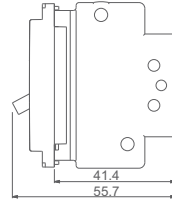

CTTDP06.17
CTTDP10.17



CTTDP16.17
CTTDP20.17



CTTDP25.17
CTTDP32.17

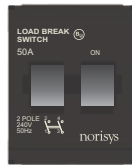

CLBDP32.17
CLBDP50.17

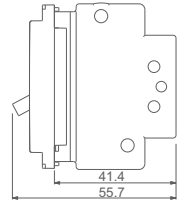

CUBE Series

Single Phase Motor Starters Charcoal Black - for mounting with CUBE Series

Cat no.	Description	
C525A .17	Motor Starter 0.60 A - 1.00 A	1/8 HP Pump
C525B .17	Motor Starter 0.90 A - 1.50 A	1/4 HP Pump
C525C .17	Motor Starter 1.20 A - 2.00 A	1/3 HP Pump
C525D .17	Motor Starter 2.00 A - 3.50 A	1/2 HP Pump
C525E .17	Motor Starter 3.00 A - 5.00 A	3/4 HP Pump
C525F .17	Motor Starter 4.75 A - 7.50 A	1 Ton AC
C525G .17	Motor Starter 7.00 A - 11.50 A	1.5 Ton AC
C525H .17	Motor Starter 11.00 A - 18.00 A	2 Ton AC
C525J .17	Motor Starter 16.00 A - 25.00 A	2.5 Ton AC

Tiny MCB Charcoal Black - for mounting with CUBE Series

CTTSP06 .17	Tiny MCB Single Pole 6A
CTTSP10 .17	Tiny MCB Single Pole 10A
CTTSP16 .17	Tiny MCB Single Pole 16A
CTTSP20 .17	Tiny MCB Single Pole 20A
CTTSP25 .17	Tiny MCB Single Pole 25A
CTTSP32 .17	Tiny MCB Single Pole 32A
CTTDP06 .17	Tiny MCB Double Pole 6A
CTTDP10 .17	Tiny MCB Double Pole 10A
CTTDP16 .17	Tiny MCB Double Pole 16A
CTTDP20 .17	Tiny MCB Double Pole 20A
CTTDP25 .17	Tiny MCB Double Pole 25A
CTTDP32 .17	Tiny MCB Double Pole 32A

81

Tiny Load Break Switch Charcoal Black - for mounting with CUBE Series

CLBDP32 .17	Tiny Load Break Switch Double Pole 32A
CLBDP50 .17	Tiny Load Break Switch Double Pole 50A



S7110 .01
S7130 .01



S7210 .01
S7230 .01



S7111 .01
S7131 .01
S7731 .01



S7211 .01
S7231 .01



S7310 .01



S7311 .01

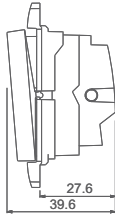

S7340 .01



S7341 .01



S7180 .01



S7191 .01
S7171 .01

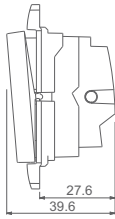

S8110 .01



S8210 .01



S8130 .01
S8730 .01



S8230 .01



S8310 .01



S8311 .01

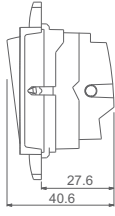

S8111 .01



S8211 .01



S8131 .01
S8731 .01



S8231 .01

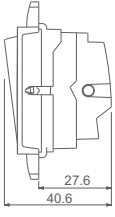

SQUARE Series

Switches Frost White

Cat no.	Description
S7110 .01	Switch 6A One-way (Collarless Style) - 1 Module
S7111 .01	Switch 6A One-way with indicator (Collarless Style) - 1 Module
S7210 .01	Switch 6A Two-way (Collarless Style) - 1 Module
S7211 .01	Switch 6A Two-way with indicator (Collarless Style) - 1 Module
S7130 .01	Switch 16A One-way (Collarless Style) - 1 Module
S7131 .01	Switch 16A One-way with indicator (Collarless Style) - 1 Module
S7230 .01	Switch 16A Two-way (Collarless Style) - 1 Module
S7231 .01	Switch 16A Two-way with indicator (Collarless Style) - 1 Module
S7731 .01	Switch 25A One-way with indicator (Collarless Style) - 1 Module
S7310 .01	Switch 6A - Bell (Collarless Style) - 1 Module
S7311 .01	Switch 6A - Bell with indicator (Collarless Style) - 1 Module
S7340 .01	Palm Bell Switch 6A (Collarless Style) - 2 Module
S7341 .01	Palm Bell Switch 6A with indicator (Collarless Style) - 2 Module
S7180 .01	Palm Switch 6A One-way Double Pole (Collarless Style) - 2 Module
S7280 .01	Palm Switch 6A Two-way Double Pole (Collarless Style) - 2 Module
S7191 .01	Palm Switch 16A One-way DP with indicator (Collarless) - 2 Module
S7291 .01	Palm Switch 16A Two-way DP with indicator (Collarless) - 2 Module
S7171 .01	Palm Switch 25A One-way DP with indicator (Collarless) - 2 Module
S8110 .01	Switch 6A One-way (Collar Style) - 1 Module
S8111 .01	Switch 6A One-way with indicator (Collar Style) - 1 Module
S8210 .01	Switch 6A Two-way (Collar Style) - 1 Module
S8211 .01	Switch 6A Two-way with indicator (Collar Style) - 1 Module
S8130 .01	Switch 16A One-way (Collar Style) - 1 Module
S8131 .01	Switch 16A One-way with indicator (Collar Style) - 1 Module
S8230 .01	Switch 16A Two-way (Collar Style) - 1 Module
S8231 .01	Switch 16A Two-way with indicator (Collar Style) - 1 Module
S8730 .01	Switch 25A One-way (Collar Style) - 1 Module
S8731 .01	Switch 25A One-way with indicator (Collar Style) - 1 Module
S8310 .01	Switch 6A - Bell (Collar Style) - 1 Module
S8311 .01	Switch 6A - Bell with indicator (Collar Style) - 1 Module



S7213 .01



S7332 .01
S7732 .01



S7412 .01



S7532 .01
S7531 .01

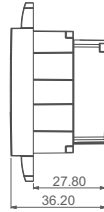

S1010 .01



S7212 .01

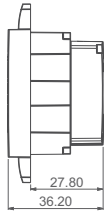

S7900 .01
S7910 .01



S7901 .01
S7911 .01



S7902 .01
S7903 .01



S7904 .01

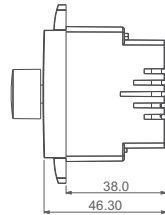

S7905 .01
S7908 .01

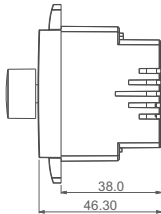

SQUARE Series

Sockets Frost White

Cat no.	Description
S7213 .01	Socket 6A 3-Pin-only Shuttered - 2 Module (As per Indian Standard)
S7332 .01	Socket 16A/6A 3-Pin Shuttered - 2 Module (As per Indian Standard)
S7212 .01	Socket 6A 3+2 Pin [Round & Flat] Shuttered - 2 Module *
S7412 .01	Socket 6A 3+2 Pin And 2 pin Shuttered - 2 Module *
S1010 .01	Socket 6A 2 Pin [Round & Flat] - 1 Module *
S7532 .01	Socket 13A International Multi-Socket Shuttered - 2 Module *
S7531 .01	Socket 13A 3-Pin Flat Socket Shuttered - 2 Module *
S7732 .01	Socket 25A/6A 3-Pin Shuttered - 2 Module *

Fan Regulators & Dimmers Frost White

S7900 .01	Fan Regulator Step Type with Bar Knob for 80W fan - 2 Module
S7901 .01	Fan Regulator Step Type with Round Knob for 80W fan - 2 Module
S7910 .01	Fan Regulator Step Type with Bar Knob for 120W fan - 2 Module
S7911 .01	Fan Regulator Step Type with Round Knob for 120W fan - 2 Module
S7902 .01	Dimmer 500 Watts - 2 Module
S7903 .01	Dimmer 1000 Watts - 2 Module
S7904 .01	Fan Regulator Single Module for 80W Fan - Step Type - 1 Module
S7905 .01	Dimmer 500 Watts - 1 Module
S7908 .01	Dimmer for LED Lights (3 wire system) - 1 Module

89

* Only for export outside India



S7797 .01



S7800 .01
S7101 .01



S7820 .01



S7600 .01



S7802 .01
S7100 .01



S7725 .01
S7736 .01

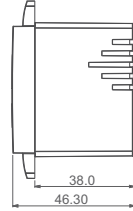

S7836 .01



S7936 .01



S7729 .01

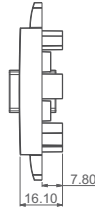

SQUARE Series

Communique' Frost White

Cat no.	Description
S7797 .01	Coaxial T.V Socket - 1 Module
S7800 .01	Telephone Socket RJ-11 Double Line Shuttered - 1 Module
S7820 .01	Twin Telephone Socket RJ-11 - 1 Module
S7802 .01	Information Socket 6e - UTP Shuttered - 1 Module
S7100 .01	Information Socket 6a - UTP Shuttered - 1 Module
S7725 .01	USB Extension Socket - 1 Module
S7736 .01	USB Charger Socket Outlet A Type- 2.1 Amps - 1 Module
S7836 .01	USB Charger Socket Outlet C Type - 2.1 Amps - 1 Module
S7936 .01	USB Charger Socket Outlet A+C Type - 2.1 Amps - 1 Module
S7729 .01	Computer Monitor Output Socket - 1 Module
S7101 .01	Fitment for RJ-45 Computer Socket Shuttered - 1 Module
S7600 .01	Indicator Light - 1 Module



S7232 .01



S7233 .01



S8232 .01



S8233 .01



S7262 .01

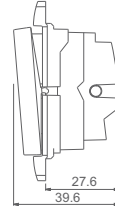

S7711 .01



S7450 .01

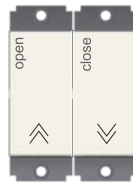

S7460 .01



S7500 .01

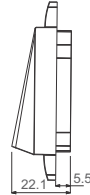

S7706 .01
S7707 .01
S7709 .01



S7721 .01



S7700 .01



S7798 .01

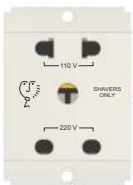
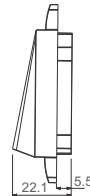

S7723 .01



S7719 .01



S7720 .01

SQUARE Series

Hospitality Modules Frost White

Cat no.	Description
S7232 .01	"Do Not Disturb" Switch with indicator (Collarless Style) - 1 Module
S7233 .01	"Clean My Room" Switch with indicator (Collarless Style) - 1 Module
S8232 .01	"Do Not Disturb" Switch with indicator (Collar Style) - 1 Module
S8233 .01	"Clean My Room" Switch with indicator (Collar Style) - 1 Module
S7262 .01	Bell Switch with "Do Not Disturb" and "Clean My Room" indicator - 2M
S7711 .01	Call Bell Station with Register and Provision for External Buzzer - 2M
S7719 .01	25A Key Fob Switch Double Pole with indicator - 2 Module
S7720 .01	Key Fob - customized
S7723 .01	Shaver Socket 220V / 110V with transformer - 2 module
S7450 .01	Push Button Station Start - Stop (Collorless Style) - 2 Module
S7460 .01	Push Button Station Open - Close (Collorless Style) - 2 Module

93

Acoustic and Optical Signaling Frost White

S7706 .01	Speaker for audio music circuit - 2 Module
S7707 .01	Electronic Bell - 2 Module
S7709 .01	Electronic Buzzer - 2 Module
S7721 .01	Step Marker Lamp / Night Lamp - 2 Module
S7798 .01	Audio Port / Jack 3.5mm - 1 Module

Support Modules Frost White

S7500 .01	Cord Outlet - 1 Module
S7700 .01	Blanking Plate - 1 Module



S7110 .23



S7210 .23



S7111 .23



S7211 .23



S7310 .23



S7311 .23

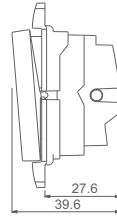

S7130 .23



S7230 .23



S7131 .23



S7731 .23



S7231 .23

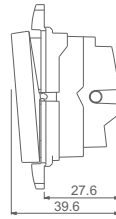

94



S7340 .23



S7341 .23



S7180 .23



S7191 .23

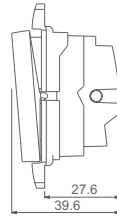

S7171 .23

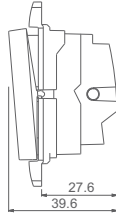

SQUARE Series

Switches Graphite Gray

Cat no.	Description
S7110 .23	Switch 6A One-way (Collarless Style) - 1 Module
S7111 .23	Switch 6A One-way with indicator (Collarless Style) - 1 Module
S7210 .23	Switch 6A Two-way (Collarless Style) - 1 Module
S7211 .23	Switch 6A Two-way with indicator (Collarless Style) - 1 Module
S7130 .23	Switch 16A One-way (Collarless Style) - 1 Module
S7131 .23	Switch 16A One-way with indicator (Collarless Style) - 1 Module
S7230 .23	Switch 16A Two-way (Collarless Style) - 1 Module
S7231 .23	Switch 16A Two-way with indicator (Collarless Style) - 1 Module
S7731 .23	Switch 25A One-way with indicator (Collarless Style) - 1 Module
S7310 .23	Switch 6A - Bell (Collarless Style) - 1 Module
S7311 .23	Switch 6A - Bell with indicator (Collarless Style) - 1 Module
S7340 .23	Palm Bell Switch 6A (Collarless Style) - 2 Module
S7341 .23	Palm Bell Switch 6A with indicator (Collarless Style) - 2 Module
S7180 .23	Palm Switch 6A One-way Double Pole (Collarless Style) - 2 Module
S7280 .23	Palm Switch 6A Two-way Double Pole (Collarless Style) - 2 Module
S7191 .23	Palm Switch 16A One-way DP with indicator (Collarless) - 2 Module
S7291 .23	Palm Switch 16A Two-way DP with indicator (Collarless) - 2 Module
S7171 .23	Palm Switch 25A One-way DP with indicator (Collarless) - 2 Module



S7213 .23



S7332 .23
S7732 .23



S7412 .23



S7532 .23
S7531 .23

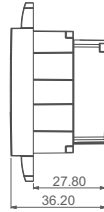

S1010 .23



S7212 .23

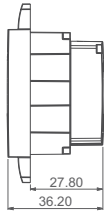

S7900 .23
S7910 .23



S7901 .23
S7911 .23



S7902 .23
S7903 .23



S7904 .23

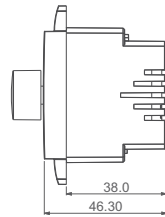

S7905 .23
S7908 .23

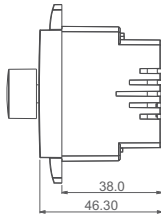

SQUARE Series

Sockets Graphite Gray

Cat no.	Description
S7213 .23	Socket 6A 3-Pin-only Shuttered - 2 Module (As per Indian Standard)
S7332 .23	Socket 16A/6A 3-Pin Shuttered - 2 Module (As per Indian Standard)
S7212 .23	Socket 6A 3+2 Pin [Round & Flat] Shuttered - 2 Module *
S7412 .23	Socket 6A 3+2 Pin And 2 pin Shuttered - 2 Module *
S1010 .23	Socket 6A 2 Pin [Round & Flat] - 1 Module *
S7532 .23	Socket 13A International Multi-Socket Shuttered - 2 Module *
S7531 .23	Socket 13A 3-Pin Flat Socket Shuttered - 2 Module *
S7732 .23	Socket 25A/6A 3-Pin Shuttered - 2 Module *

Fan Regulators & Dimmers Graphite Gray

S7900 .23	Fan Regulator Step Type with Bar Knob for 80W fan - 2 Module
S7901 .23	Fan Regulator Step Type with Round Knob for 80W fan - 2 Module
S7910 .23	Fan Regulator Step Type with Bar Knob for 120W fan - 2 Module
S7911 .23	Fan Regulator Step Type with Round Knob for 120W fan - 2 Module
S7902 .23	Dimmer 500 Watts - 2 Module
S7903 .23	Dimmer 1000 Watts - 2 Module
S7904 .23	Fan Regulator Single Module for 80W Fan - Step Type - 1 Module
S7905 .23	Dimmer 500 Watts - 1 Module
S7908 .23	Dimmer for LED Lights (3 wire system) - 1 Module

97

* Only for export outside India



S7797 .23



S7800 .23
S7101 .23



S7820 .23



S7600 .23



S7802 .23
S7100 .23



S7725 .23
S7736 .23

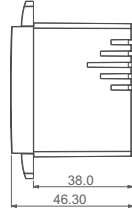

S7836 .23



S7936 .23



S7729 .23

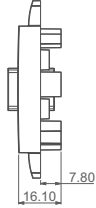

SQUARE Series

Communique' Graphite Gray

Cat no.	Description
S7797 .23	Coaxial T.V Socket - 1 Module
S7800 .23	Telephone Socket RJ-11 Double Line Shuttered - 1 Module
S7820 .23	Twin Telephone Socket RJ-11 - 1 Module
S7802 .23	Information Socket 6e - UTP Shuttered - 1 Module
S7100 .23	Information Socket 6a - UTP Shuttered - 1 Module
S7725 .23	USB Extension Socket - 1 Module
S7736 .23	USB Charger Socket Outlet A Type - 2.1 Amps - 1 Module
S7836 .23	USB Charger Socket Outlet C Type - 2.1 Amps - 1 Module
S7936 .23	USB Charger Socket Outlet A+C Type - 2.1 Amps - 1 Module
S7729 .23	Computer Monitor Output Socket - 1 Module
S7101 .23	Fitment for RJ-45 Computer Socket Shuttered - 1 Module
S7600 .23	Indicator Light - 1 Module



S7232 .23



S7233 .23



S7706 .23

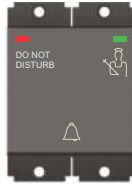

S7262 .23

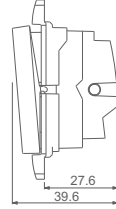

S7711 .23



S7450 .23

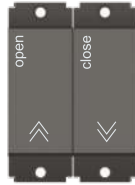

S7460 .23



S7500 .23

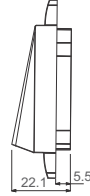

S7707 .23
S7709 .23



S7721 .23



S7700 .23



S7798 .23

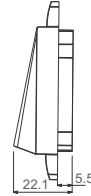

S7723 .23



S7719 .23



S7720 .23

SQUARE Series

Hospitality Modules Graphite Gray

Cat no.	Description
S7232 .23	"Do Not Disturb" Switch with indicator (Collarless Style) - 1 Module
S7233 .23	"Clean My Room" Switch with indicator (Collarless Style) - 1 Module
S7262 .23	Bell Switch with "Do Not Disturb" and "Clean My Room" indicator - 2M
S7711 .23	Call Bell Station with Register and Provision for External Buzzer - 2M
S7719 .23	25A Key Fob Switch Double Pole with indicator - 2 Module
S7720 .23	Key Fob - customized
S7723 .23	Shaver Socket 220V / 110V with transformer - 2 module
S7450 .23	Push Button Station Start - Stop (Collarless Style) - 2 module
S7460 .23	Push Button Station Open - Close (Collarless Style) - 2 module

Acoustic and Optical Signaling Graphite Gray

S7706 .23	Speaker for audio music circuit - 2 Module
S7707 .23	Electronic Bell - 2 Module
S7709 .23	Electronic Buzzer - 2 Module
S7721 .23	Step Marker Lamp / Night Lamp - 2 Module
S7798 .23	Audio Port / Jack 3.5mm - 1 Module

101

Support Modules Graphite Gray

S7500 .23	Cord Outlet - 1 Module
S7700 .23	Blanking Plate - 1 Module



S7601 .01 S7601 .25
S7601 .03 S7601 .27
S7601 .23



S7602 .01 S7602 .25
S7602 .03 S7602 .27
S7602 .23



S7633 .01 S7633 .25
S7633 .03 S7633 .27
S7633 .23

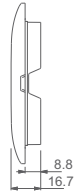

S7631 .01 S7631 .25
S7631 .03 S7631 .27
S7631 .23

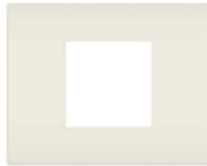

S7632 .01 S7632 .25
S7632 .03 S7632 .27
S7632 .23



S7604 .01 S7604 .25
S7604 .03 S7604 .27
S7604 .23

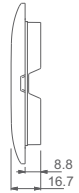

102



S7606 .01 S7606 .25
S7606 .03 S7606 .27
S7606 .23



S7608 .01 S7608 .25
S7608 .03 S7608 .27
S7608 .23

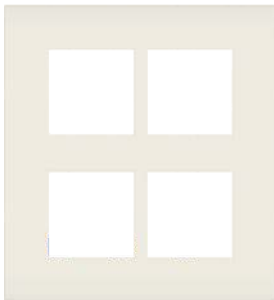

S7609 .01 S7609 .25
S7609 .03 S7609 .27
S7609 .23

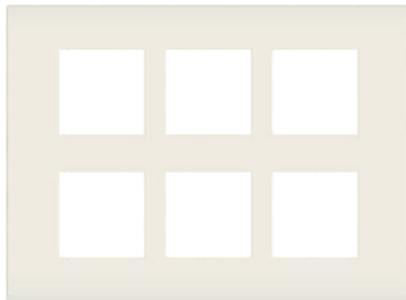

S7612 .01 S7612 .25
S7612 .03 S7612 .27
S7612 .23

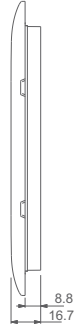

SQUARE Series

Smart Plates with frames Frost White and Wood Finish

Description	Frost White	Wood Finish
	Cat no.	Cat no.
1M Plate - for 75mm x 75mm box (3x3)	S7601 .01	S7601 .27
2M Plate - for 75mm x 75mm box (3x3)	S7602 .01	S7602 .27
3M Plate - for 100mm x 75mm box (4x3)	S7633 .01	S7633 .27
1M Plate - for 100mm x 75mm box (4x3)	S7631 .01	S7631 .27
2M Plate - for 100mm x 75mm box (4x3)	S7632 .01	S7632 .27
4M Plate - for 135mm x 75mm box (5x3)	S7604 .01	S7604 .27
6M Plate - for 210mm x 75mm box (8x3)	S7606 .01	S7606 .27
8M Plate - for 230mm x 75mm box (9x3)	S7608 .01	S7608 .27
8M(V) Plate - for 135mm x 140mm box (5x5)	S7609 .01	S7609 .27
12M Plate - for 140mm x 210mm box (8x6)	S7612 .01	S7612 .27
18M Plate - for 210mm x 210mm box (8x8)	S7618 .01	S7618 .27

103

Smart Plates with frames Graphite Gray, Cocoa Brown and Ice Silver

Description	Graphite Gray	Cocoa Brown	Ice Silver
	Cat no.	Cat no.	Cat no.
1M Plate	S7601 .23	S7601 .25	S7601 .03
2M Plate	S7602 .23	S7602 .25	S7602 .03
3M Plate	S7633 .23	S7633 .25	S7633 .03
1M Plate	S7631 .23	S7631 .25	S7631 .03
2M Plate	S7632 .23	S7632 .25	S7632 .03
4M Plate	S7604 .23	S7604 .25	S7604 .03
6M Plate	S7606 .23	S7606 .25	S7606 .03
8M Plate	S7608 .23	S7608 .25	S7608 .03
8M(V) Plate	S7609 .23	S7609 .25	S7609 .03
12M Plate	S7612 .23	S7612 .25	S7612 .03
18M Plate	S7618 .23	S7618 .25	S7618 .03

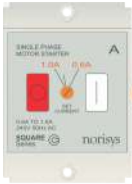

S725A .01



S725B .01



S725C .01



S725D .01

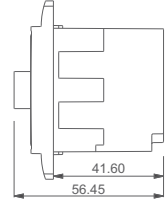

S725E .01

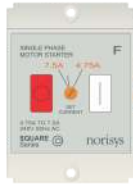

S725F .01



S725G .01



S725H .01

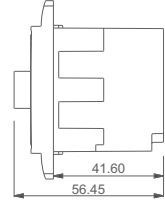

S725J .01

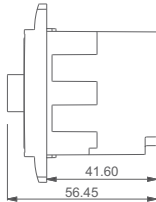

SQUARE Series

Single Phase Motor Starters Screw-mounting type - Frost White

Cat no.	Description
S725A .01	Motor Starter 0.60 A - 1.00 A 1/8 HP Pump
S725B .01	Motor Starter 0.90 A - 1.50 A 1/4 HP Pump
S725C .01	Motor Starter 1.20 A - 2.00 A 1/3 HP Pump
S725D .01	Motor Starter 2.00 A - 3.50 A 1/2 HP Pump
S725E .01	Motor Starter 3.00 A - 5.00 A 3/4 HP Pump
S725F .01	Motor Starter 4.75 A - 7.50 A 1 Ton AC
S725G .01	Motor Starter 7.00 A - 11.50 A 1.5 Ton AC
S725H .01	Motor Starter 11.00 A - 18.00 A 2 Ton AC
S725J .01	Motor Starter 16.00 A - 25.00 A 2.5 Ton AC



STTSP06
.01



STTSP10
.01



STTSP16
.01



STTSP20
.01



STTSP25
.01



STTSP32
.01

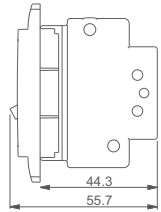

STTDP06 .01



STTDP10 .01



STTDP16 .01



STTDP20 .01

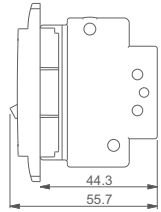

STTDP25 .01



STTDP32 .01



SLBDP32 .01



SLBDP50 .01

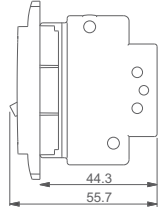

SQUARE Series

Tiny MCBs - Screw Mounting Type Frost White

Cat no.	Description
STTSP06 .01	Tiny MCB Single Pole 6A
STTSP10 .01	Tiny MCB Single Pole 10A
STTSP16 .01	Tiny MCB Single Pole 16A
STTSP20 .01	Tiny MCB Single Pole 20A
STTSP25 .01	Tiny MCB Single Pole 25A
STTSP32 .01	Tiny MCB Single Pole 32A
STTDP06 .01	Tiny MCB Double Pole 6A
STTDP10 .01	Tiny MCB Double Pole 10A
STTDP16 .01	Tiny MCB Double Pole 16A
STTDP20 .01	Tiny MCB Double Pole 20A
STTDP25 .01	Tiny MCB Double Pole 25A
STTDP32 .01	Tiny MCB Double Pole 32A

107

Tiny Load Break Switch - Screw Mounting Type Frost White

SLBDP32 .01	Tiny Load Break Switch Double Pole 32A
SLBDP50 .01	Tiny Load Break Switch Double Pole 50A

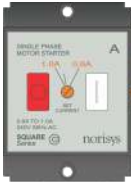

S725A .23

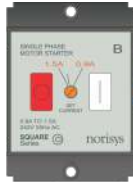

S725B .23



S725C .23



S725D .23



S725E .23

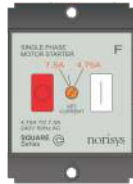

S725F .23



S725G .23



S725H .23



S725J .23



SQUARE Series

Single Phase Motor Starters Screw-mounting type - Graphite Gray

Cat no.	Description
S725A .23	Motor Starter 0.60 A - 1.00 A 1/8 HP Pump
S725B .23	Motor Starter 0.90 A - 1.50 A 1/4 HP Pump
S725C .23	Motor Starter 1.20 A - 2.00 A 1/3 HP Pump
S725D .23	Motor Starter 2.00 A - 3.50 A 1/2 HP Pump
S725E .23	Motor Starter 3.00 A - 5.00 A 3/4 HP Pump
S725F .23	Motor Starter 4.75 A - 7.50 A 1 Ton AC
S725G .23	Motor Starter 7.00 A - 11.50 A 1.5 Ton AC
S725H .23	Motor Starter 11.00 A - 18.00 A 2 Ton AC
S725J .23	Motor Starter 16.00 A - 25.00 A 2.5 Ton AC



STTSP06 .23



STTSP10 .23



STTSP16 .23



STTSP20 .23



STTSP25 .23



STTSP32 .23

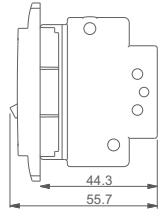

STTDP06 .23



STTDP10 .23



STTDP16 .23



STTDP20 .23

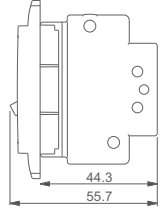

STTDP25 .23



STTDP32 .23

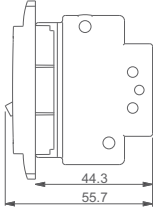

SLBDP32 .23



SLBDP50 .23

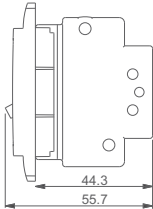

SQUARE Series

Tiny MCBs - Screw Mounting Type Graphite Gray

Cat no.	Description
STTSP06 .23	Tiny MCB Single Pole 6A
STTSP10 .23	Tiny MCB Single Pole 10A
STTSP16 .23	Tiny MCB Single Pole 16A
STTSP20 .23	Tiny MCB Single Pole 20A
STTSP25 .23	Tiny MCB Single Pole 25A
STTSP32 .23	Tiny MCB Single Pole 32A
STTDP06 .23	Tiny MCB Double Pole 6A
STTDP10 .23	Tiny MCB Double Pole 10A
STTDP16 .23	Tiny MCB Double Pole 16A
STTDP20 .23	Tiny MCB Double Pole 20A
STTDP25 .23	Tiny MCB Double Pole 25A
STTDP32 .23	Tiny MCB Double Pole 32A

111

Tiny Load Break Switch - Screw Mounting Type Graphite Gray

SLBDP32 .23	Tiny Load Break Switch Double Pole 32A
SLBDP50 .23	Tiny Load Break Switch Double Pole 50A



PU3MFT .01



PU4MFT .01



PU6MFT .01



PU3MBT .01



PU4MBT .01



PU6MBT .01

SQUARE Series

Pre-wired Power Units Frost White

Cat no.	Description
PU3MFT .01	Power Unit Flush Type with MCB + 25A Plug & Socket
PU3MBT .01	Power Unit in Surface Box with MCB + 25A Plug & Socket
PU4MFT .01	Power Unit Flush Type with Starter + 25A Plug & Socket
PU4MBT .01	Power Unit in Surface Box with Starter + 25A Plug & Socket
PU6MFT .01	Power Unit Flush Type with MCB + Starter + 25A Plug & Socket
PU6MBT .01	Power Unit in Surface Box MCB + Starter + 25A Plug & Socket



MB501 .01
SB501 .01



MB503 .01
SB503 .01



MB504 .01
SB504 .01



MB506 .01
SB506 .01



MB508 .01
SB508 .01



MB509 .01
SB509 .01



MB512 .01
SB512 .01



SM702 .01



SM703 .01



SM704 .01

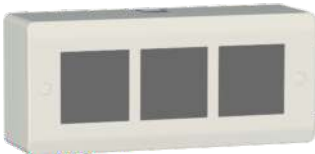

SM706 .01

Wiring Boxes

Superior Anti-Rust Stainless Steel Boxes Suitable for CUBE Series

Cat no.	Description	Suitable plate size in Cube Series	Suitable plate size in Square Series
SB501 .01	75mm X 75mm X 50mm (3x3)	1M, 2M	1M, 2M
SB503 .01	100mm X 75mm X 50mm (4x3)	3M	1M, 2M, 3M
SB504 .01	135mm X 75mm X 50mm (5x3)	4M	4M
SB506 .01	210mm X 75mm X 50mm (8x3)	6M, 8M	6M
SB508 .01	230mm X 75mm X 50mm (9x3)	8M	8M
SB509 .01	135mm X 140mm X 50mm (5x5)	8M	8M
SB512 .01	140mm X 210mm X 50mm (8x6)	12M, 14M	12M
SB521 .01	210mm X 210mm X 50mm (8x8)	21M	18M

Metal Boxes Suitable for CUBE Series & SQUARE Series

83

MB501 .01	75mm X 75mm X 50mm (3x3)	1M, 2M	1M, 2M
MB503 .01	100mm X 75mm X 50mm (4x3)	3M	1M, 2M, 3M
MB504 .01	135mm X 75mm X 50mm (5x3)	4M	4M
MB506 .01	210mm X 75mm X 50mm (8x3)	6M, 8M	6M
MB508 .01	230mm X 75mm X 50mm (9x3)	8M	8M
MB509 .01	135mm X 140mm X 50mm (5x5)	8M	8M
MB512 .01	140mm X 210mm X 50mm (8x6)	12M, 14M	12M
MB521 .01	210mm X 210mm X 50mm (8x8)	21M	18M

Plastic Surface Boxes Frost White

SM702 .01	2 Module Surface Box 94mm X 94mm X 60mm (3.5 x 3.5)
SM703 .01	3 Module Surface Box 118mm X 94mm X 60mm (4.5 x 3.5)
SM704 .01	4 Module Surface Box 150mm X 94mm X 60mm (6 x 3.5)
SM706 .01	6 Module Surface Box 205mm X 94mm X 60mm (8 x 3.5)

CUBE Series exploded view

Solid, heavy products with fine precision engineering resulting in trouble-free operation.

Cover plate can be snap fit onto the frames after final painting of walls.

Strong and precise locks for sturdy mounting and easy removal.

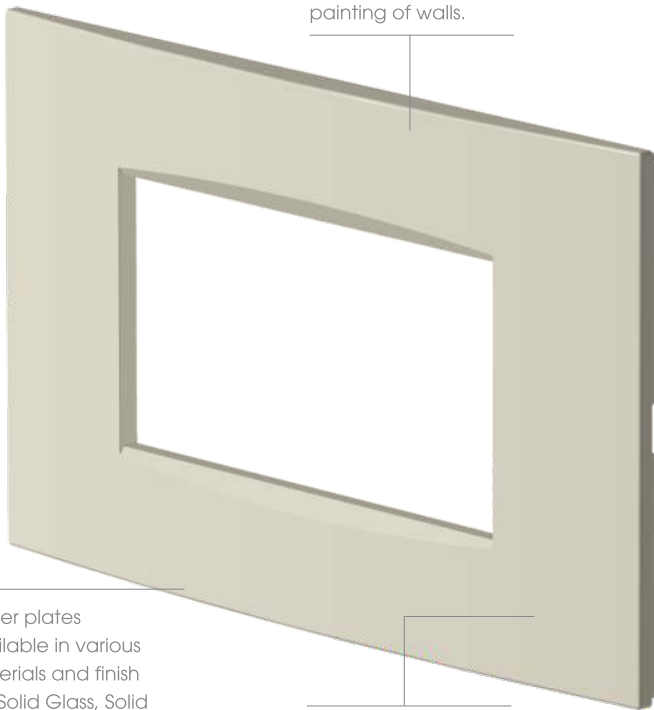

Cover plates available in various materials and finish like Solid Glass, Solid Aluminum, Solid Wood and Solid Marble Finish.

Thermoplastic plates available in 2 options - Smart Plates and Vector Plates.

Front covers of modules made of virgin grade polycarbonate in 2 colour options - Frost White & Quartz Gray.

Thermoset material which can be seen in red colour is used inside to house the live metal parts. This material is extremely high heat resistant and does not melt on heating.

Sockets with elliptical spring loaded tubes for a firm and uniform grip on the plug pins ensuring unwavering contact.

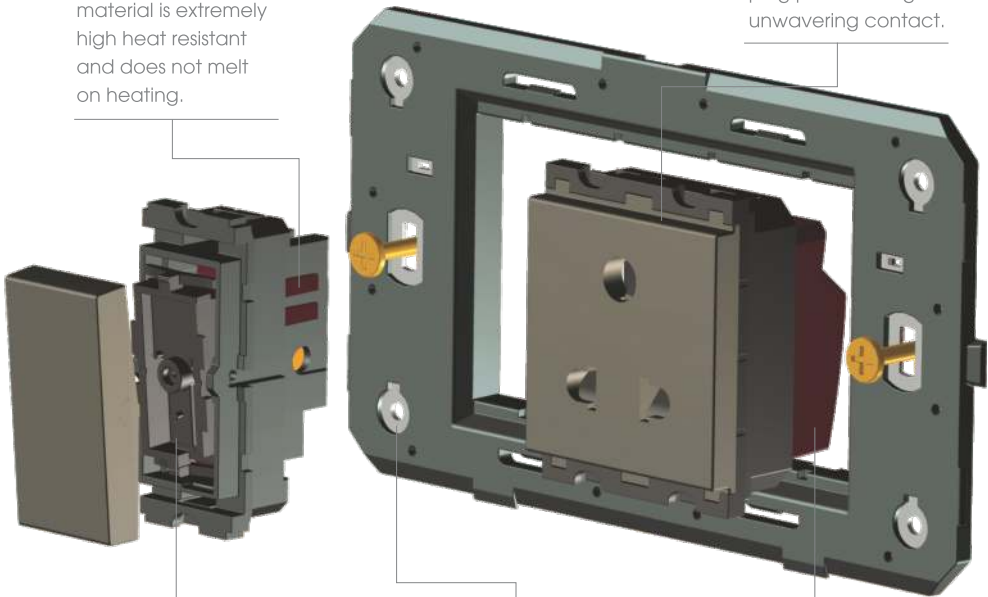

Inner shield for extra safety. It prevents the arcing from coming in contact with the front rocker. Also muffles the operating sound.

Bi-material frames that have high quality steel embedded inside thermoplastic. A result of advanced engineering, this combination leads to extra stiffness and tight tolerances for mounting of modules.

Live metal parts in sockets are enclosed in a housing made of thermoset material which is extremely high heat resistant and is capable of handling higher operating currents.

SQUARE Series exploded view

Time tested products which have evolved over a period of time - with the latest in technology.

Cover plate can be snap fit onto the frames after final painting of walls.

Modules are mounted on the frame using screws making it a fool-proof and durable mounting system.

118

Cover plates made from virgin grade, UV stabilized polycarbonate for a flawless glossy look that lasts longer.

Smart Plates that have a classic contour profile - a look unwavering by changes in fashion.

Front covers of modules made of virgin grade polycarbonate.

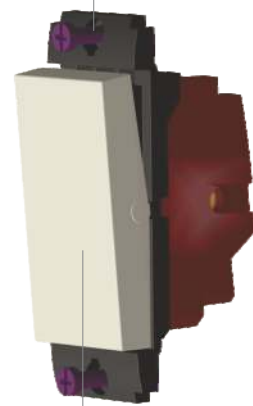
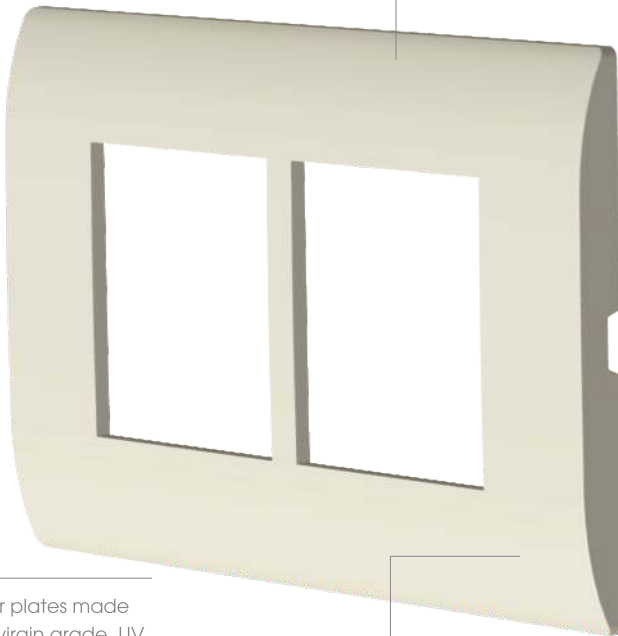

Thermoset material which can be seen in red colour is used inside to house the live metal parts. This material is extremely high heat resistant and does not melt on heating.

Sockets with elliptical spring loaded tubes for a firm and uniform grip on the plug pins ensuring unwavering contact.

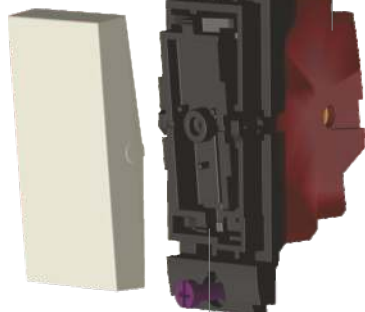

Inner shield for extra safety. It prevents the arcing from coming in contact with the front rocker. Also muffles the operating sound.

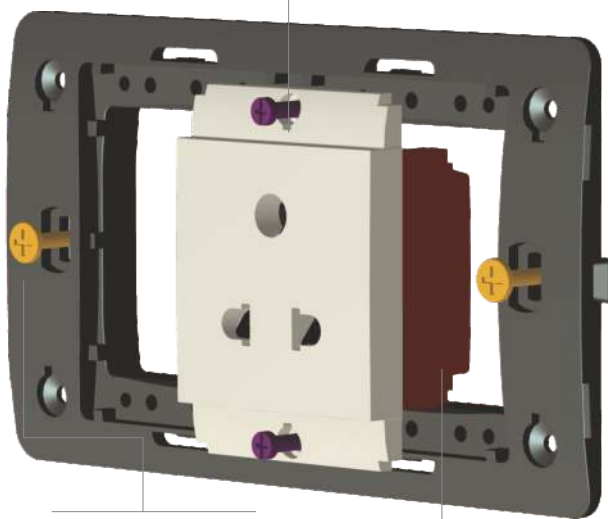

Tough frames that have unique locator slots that guide the modules to its accurate mounting location - thus ensuring uniform gaps in fitment. Steel channels at the rear give additional strength to the frames for rigidity.

Live metal parts in sockets are enclosed in thermoset material that is extremely high heat resistant and is capable of handling higher operating currents.





norisys[®]



@All rights reserved. Norisys is a registered trademark.

Wiring of electrical products should be done by trained professionals following all safety norms.

@Alle Rechte vorbehalten. Norisys ist eine eingetragene Marke.

Elektroinstallationen dürfen nur von entsprechend ausgebildeten Fachkräften unter Beachtung der maßgeblichen Sicherheitsrichtlinien vorgenommen werden.

Headquarters

Norisys Technology Private Limited
14/3 Mathura Road
Faridabad - 121 003, India

CIN: U31101DL1987PTC026630

Toll free: 1 800 11 1617

Tel: +91 11 49126360, 42657036

WhatsApp: +91 95 600 24771

Email: sales@norisys.com

Web: www.norisys.com